



PEGASUS

IMPORTANT

READ CAREFULLY BEFORE USE

KEEP SAFE TO CONSULT AT A LATER DATE

Bicycle Operating Instructions

Contents

1	About these instructions	5	3.5	Description of controls and screens	20
1.1	Manufacturer	5	3.5.1	Handlebars	20
1.2	Language	5	3.6	Environmental requirements	21
1.3	Laws, standards and directives	5	4	Transporting and storing	23
1.4	For your information	5	4.1	Shipment	23
1.4.1	Warnings	5	4.2	Transportation	23
1.4.2	Markups	6	4.2.1	Using the brake transport securing system	23
1.5	Model plate	7	4.3	Storing	23
1.6	Identifying instructions	7	5	Assembly	24
2	Safety	8	5.1	Required tools	24
2.1	Residual risks	8	5.2	Unpacking	24
2.1.1	Fire hazard	8	5.2.1	Scope of delivery	24
2.1.1.1	Overheated brakes	8	5.3	Commissioning	24
2.1.2	Risk of a crash	8	5.3.1	Installing the wheel in the Suntour fork	25
2.1.2.1	Incorrect quick release setting	8	5.3.1.1	Screw-on axle (15 mm)	25
2.1.2.2	Incorrect tightening torque	8	5.3.1.2	Screw-on axle (20 mm)	25
2.1.3	Risk of amputation	8	5.3.1.3	Quick release axle	26
2.2	Toxic substances	8	5.3.1.4	Quick release	27
2.2.1	Brake fluid	8	5.3.2	Installing the wheel in the FOX fork	28
2.2.2	Suspension oil	8	5.3.2.1	Quick release (15 mm)	28
2.3	Requirements for the rider	8	5.3.2.2	Kabolt axle	29
2.4	Vulnerable groups	8	5.3.3	Checking the stem and handlebars	29
2.5	Personal protective equipment	8	5.3.3.1	Checking the connections	29
2.6	Safety markings and safety instructions	9	5.3.3.2	Firm hold	30
2.7	What to do in an emergency	9	5.3.3.3	Checking the headset backlash	30
2.7.1	Dangerous situation in road traffic	9	5.4	Selling the bicycle	30
2.7.2	Leaked brake fluid	9	6	Operation	31
2.7.3	Oil and lubricant leaks from the fork	9	6.1	Risks and hazards	31
2.7.4	Oil and lubricant leaks from the rear frame damper	9	6.2	Personal protective equipment	32
3	Overview	10	6.3	Instruction and customer service	33
3.1	Description	11	6.4	Adjusting the bicycle	33
3.1.1	Wheel	11	6.4.1	Adjusting the saddle	33
3.1.1.1	Valve	11	6.4.1.1	Adjusting the saddle tilt	33
3.1.2	Suspension	11	6.4.1.2	Determining the seat height	33
3.1.2.1	Rigid fork	11	6.4.1.3	Adjusting the seat height with quick release	34
3.1.2.2	Suspension fork	11	6.4.1.4	Adjusting the seat position	34
3.1.2.3	Rear frame damper	14	6.4.2	Adjusting the handlebars	35
3.1.2.4	Suntour rear frame damper	15	6.4.3	Adjusting the stem	35
3.1.2.5	RockShox rear frame damper	15	6.4.3.1	Adjusting the height of the handlebars	35
3.1.3	Brake system	16	6.4.3.2	Adjusting the quick release clamping force	35
3.1.3.1	Rim brake	16	6.4.4	Adjusting the brake	35
3.1.3.2	Disc brake	16	6.4.5	Retracting the brake linings	36
3.1.3.3	Back-pedal brake	17	6.4.5.1	Setting the grip distance on a Magura HS33 brake lever	36
3.1.4	Drive system	17	6.4.5.2	Setting the grip distance on a Magura HS22 brake lever	36
3.2	Proper use	18			
3.3	Improper use	19			
3.4	Technical data	20			
3.4.1	Bicycle	20			
3.4.2	Tightening torque	20			

6.4.5.3	Setting the grip distance on a Magura disc brake lever	37	6.12	Gear shift	58
6.4.5.4	Setting the pressure point on a Magura brake lever	37	6.12.1	Using the derailleur gears	58
6.4.6	Adjusting the damping sag	38	6.12.2	Using a hub gear	58
6.4.6.1	Adjusting the Suntour fork steel suspension	39	6.13	Parking the bicycle	60
6.4.6.2	Adjusting the Suntour fork air suspension	39	7	Cleaning and servicing	61
6.4.6.3	Adjusting the Suntour rear frame damper	40	7.1	Cleaning after each ride	62
6.4.6.4	Adjusting the RockShox fork steel suspension	41	7.1.1	Cleaning the suspension fork	62
6.4.6.5	Adjusting the RockShox air suspension	41	7.1.2	Cleaning the rear frame damper	62
6.4.6.6	Adjusting the RockShox rear frame damper	42	7.1.3	Cleaning the pedals	62
6.4.7	Adjusting the rebound damping	44	7.2	Basic cleaning	62
6.4.7.1	Adjusting the Suntour air suspension fork	45	7.2.1	Cleaning the frame	62
6.4.7.2	Adjusting the Suntour rear frame damper	45	7.2.2	Cleaning the stem	62
6.4.7.3	Adjusting the RockShox suspension fork	46	7.2.3	Cleaning the wheel	62
6.4.7.4	Adjusting the RockShox rear frame damper	46	7.2.4	Cleaning the drive elements	63
6.4.8	Rear frame damper compression adjuster	47	7.2.5	Cleaning the rear frame damper	63
6.4.8.1	Adjusting the Suntour rear frame damper	48	7.2.6	Cleaning the chain	63
6.4.8.2	Adjusting the RockShox compression adjuster	48	7.2.7	Cleaning the brake	63
6.5	Accessories	49	7.2.8	Cleaning the saddle	63
6.5.1	Child seat	49	7.3	Servicing	64
6.5.2	Trailer	50	7.3.1	Servicing the frame	64
6.5.2.1	Trailer approval for ENVIOLLO hub gear	50	7.3.2	Servicing the stem	64
6.5.3	Pannier rack	51	7.3.3	Servicing the fork	64
6.5.4	Suspension fork coil spring	51	7.3.4	Servicing the drive elements	64
6.5.5	Tubeless and airless	51	7.3.5	Servicing the pedals	64
6.6	Before each ride	52	7.3.6	Servicing the chain	64
6.7	Raising the kickstand	53	7.4	Maintenance	64
6.8	Using the pannier rack	53	7.4.1	Wheel	64
6.9	Using the saddle	53	7.4.1.1	Checking the tyres	64
6.10	Brake	54	7.4.1.2	Checking the rims	64
6.10.1	Using the brake lever	54	7.4.1.3	Checking and adjusting the tyre pressure	65
6.10.2	Using the back-pedal brake	54	7.4.2	Brake system	66
6.11	Suspension and damping	55	7.4.3	Checking the brake linings for wear	66
6.11.1	Suspension fork compression adjuster	55	7.4.4	Checking the pressure point	66
6.11.1.1	Adjusting the Suntour compression adjuster	56	7.4.5	Checking the brake discs for wear	66
6.11.1.2	Adjusting the RockShox compression adjuster	57	7.4.6	Checking the electrical cables and brake cables	66
6.11.1.3	Adjusting the RockShox rear frame damper threshold	57	7.4.7	Checking the gear shift	66
			7.4.8	Checking the stem	66
			7.4.9	Checking the belt and chain tension	67
			8	Maintenance	68
			8.1	Suspension system	69
			8.1.1	Rear frame damper	69
			8.1.2	Suspension fork	70
			8.1.3	Suspension seat post	71
			8.2	Axle with quick release	71
			8.2.1	Checking the quick release	72
			8.3	Maintaining the stem	72
			8.4	Adjusting the gear shift	72
			8.4.1	Cable-operated gear shift, single-cable	72
			8.4.2	Cable-operated gear shift, dual-cable	73
			8.4.3	Cable-operated twist grip, dual-cable	73

9	Troubleshooting, fault clearance and repair	74
9.1	Lighting	74
9.2	Gear shift	74
9.3	Suspension fork	75
9.3.1	Rebound too fast	75
9.3.2	Rebounding too slowly	76
9.3.3	Suspension too soft on inclines	77
9.3.4	Excessively hard damping on bumps	78
9.4	Rear frame damper	79
9.4.1	Rebound too fast	79
9.4.2	Rebounding too slowly	80
9.4.3	Suspension too soft on inclines	81
9.4.4	Excessively hard damping on bumps	82
9.5	Repair	83
9.5.1	Original parts and lubricants	83
9.5.2	Replacing the lighting	83
9.5.3	Adjusting the headlight	83
9.5.4	Tyre clearance check	83
10	Recycling and disposal	84
11	Documents	85
11.1	Assembly report	85
11.2	Maintenance instructions	87
12	Glossary	89
13	Keyword index	92

Thank you for your trust!

PEGASUS *bicycles* are premium quality bicycles. You have made an excellent choice. Your specialist dealer will provide you with guidance and instruction and assemble your product. Your specialist dealer will also be happy to assist you in the future, whether you require maintenance, conversion or repair.

Notice

These *instructions* are not a substitute for personal instruction by the supplying specialist dealer.

These instructions form an integral part of the bicycle. Therefore, if it is re-sold at a later time, they must be handed over to the subsequent owner.

You are receiving these instructions with your new bicycle. Please take time to become familiar with your new bicycle. Use the tips and suggestions in the instructions. They will help you to enjoy your bicycle for a long time to come. We hope you have fun and wish you well on all of your rides!

The instructions are mainly designed for the rider and the operator. They aim to ensure that non-professionals can use the bicycle safely.



Sections are also designed especially for the specialist dealer. These sections aim to ensure that specialist dealers complete initial assembly and maintenance safely and reliably. The sections for specialist dealers are highlighted in grey and marked with a spanner symbol.



Download the operating instructions onto your phone at the following link, so that you can use them when you are out riding:

<https://www.pegasus-bikes.com/service/downloads.html>

Copyright

© ZEG Zweirad-Einkaufs-Genossenschaft eG

Distribution or reproduction of these operating instructions and utilisation or communication of their content is prohibited unless expressly approved. Any infringement will render the offender liable for compensation. All rights reserved in the event that a patent, utility model or industrial design is registered.

Editing

Text and images:

ZEG Zweirad-Einkaufs-Genossenschaft eG
Longericher Strasse 2
50739 Köln, Germany

Translation

RKT Übersetzungs- und Dokumentations-GmbH
Markenstrasse 7
40227 Düsseldorf, Germany

If you have any questions or problems regarding these instructions, please contact:

tecdoc@zeg.de

1 About these instructions

1.1 Manufacturer

The manufacturer of the bicycle is:

ZEG Zweirad-Einkaufs-Genossenschaft eG
Longericher Strasse 2
50739 Köln, Germany

Tel.: +49 221 17959 0
Fax: +49 221 1795931
E-mail: info@zeg.de

Subject to internal changes.

The information contained in these *instructions* are the approved technical specifications at the time of printing. Any significant changes are included in a new published version of the *instructions*. You will find any modifications to these *instructions* at:

<https://www.pegasus-bikes.de/service/downloads.html>.

1.2 Language

The *original instructions* are written in German. A translation is invalid without the *original instructions*.

1.3 Laws, standards and directives

The *instructions* comply with the main requirements specified in:

- ISO 4210-1: 2015-01 – Cycles – Safety requirements for bicycles
- EN 11243:2016, Cycles – Pannier racks for bicycles – Requirements and test methods
- IEC/IEEE 82079-1:2019-05 – International Standard for Preparation of information for use (instructions for use) of products
- ISO 17100:2016-05 Translation Services – Requirements for translation services.

1.4 For your information

Different markings are used in the instructions to make them easier to read.

1.4.1 Warnings

Warnings indicate hazardous situations and actions. You will find warnings in the *instructions*:



Will lead to serious or even fatal injuries if ignored. High-risk hazard.



May lead to serious or even fatal injuries if ignored. Medium-risk hazard.



May lead to minor or moderate injuries if ignored. Low-risk hazard.



May lead to material damage if ignored.

1.4.2 Markups



Instructions for specialist dealers are highlighted in grey. They are indicated by a screwdriver symbol. Information for specialist dealers does not require non-professionals to take any action.

You will find stylised forms of typeface in the *instructions*:

Stylised form	Use
<i>Italics</i>	Glossary term
<u>Underlined in blue</u>	Link
<u>Underlined in grey</u>	Cross references
✓ Check marks	Requirements
▶ Triangle	Instruction for action with a specific sequence
1 Instruction for action	Several instructions for action in specified order
⇒	Result of the action
SPACED	Indicators on the display screen
•	Bulleted lists
Only applies to bicycles with this equipment	Each type has a different kind of equipment. A note beneath the heading indicates components which can be used as an alternative.

Table 1: Markups

1.5 Model plate

The model plate is situated on the frame. You can see the exact position of the model plate in Figure 2.

There are seven pieces of information on the model plate.

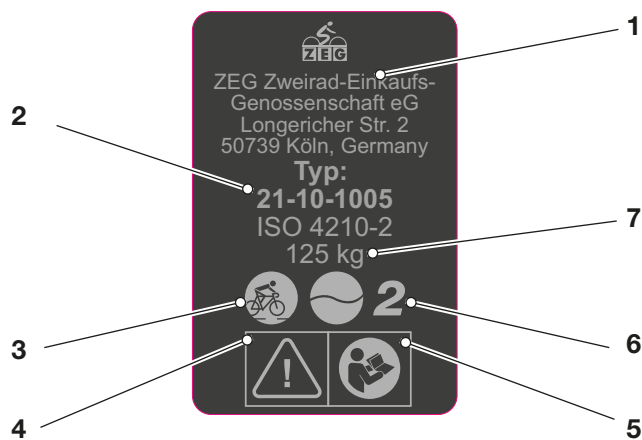

Figure 1: Example Nameplate

No.	Designation	Description
1	Manufacturer's contact details	You can contact the manufacturer at the address. You can find more information in Section 1.
2	Type number	All bicycle models have an eight-digit type number, which is used to specify the design model year, the type of bicycle and the version. You can find more information in Section 1.
3	Bicycle type	You can find more information in Section 3.2.
4	Safety markings	You can find more information in Section 1.4.
5	Safety markings	You can find more information in Section 1.4.
6	Area of use	You can find more information in Section 3.2.
7	Maximum total weight	The maximum total weight is the maximum weight of the fully assembled bicycle with the rider and baggage.

Table 2: Model plate information

1.6 Identifying instructions

The Identification number position is located on bottom left-hand side on each page. The identification number is composed of the document number, the version number and the release date.

Identification number	MY21P03 - 32_1.0_23.12.2020
------------------------------	-----------------------------

2 Safety

2.1 Residual risks

2.1.1 Fire hazard

2.1.1.1 Overheated brakes

The brakes may become very hot during operation. There is a risk of burns or fire in case of contact.

- ▶ Never touch the brakes or the motor directly after a ride.
- ▶ Never place the bicycle on a flammable surface, such as grass or wood, directly after use.

2.1.2 Risk of a crash

2.1.2.1 Incorrect quick release setting

Excessively high clamping force will damage the quick release and cause it to lose its function. Insufficient clamping force will result in unfavourable transmission of force. This can cause components to break. This will cause a crash with injuries.

- ▶ Never fasten a quick release using a tool (e.g. hammer or pliers).
- ▶ Only use the clamping lever with the specified set clamping force.

2.1.2.2 Incorrect tightening torque

If a screw is fastened too tightly, it may break. If a screw is not fastened enough, it may loosen. This will cause a crash with injuries.

- ▶ Always observe the indicated torque on the screw or in the *instructions*.

2.1.3 Risk of amputation

The brake disc in disc brakes is so sharp that it can cause serious injuries to fingers if they are inserted into the brake disc openings.

- ▶ Always keep fingers well away from the rotating brake discs.

2.2 Toxic substances

2.2.1 Brake fluid

Brake fluid may leak out after an accident or due to material fatigue. Brake fluid can be fatal if swallowed or inhaled.

- ▶ Never dismantle the brake system.
- ▶ Avoid contact with skin.
- ▶ Do not inhale vapours.

2.2.2 Suspension oil

Suspension oil in the fork and the rear frame damper is toxic to the touch, irritates respiratory tracts and causes cancer, sterility and mutation in germ cells.

- ▶ Never dismantle the rear frame damper or the suspension fork.
- ▶ Avoid contact with skin.

2.3 Requirements for the rider

The rider must demonstrate adequate physical, motor and mental abilities to ride on public roads.

2.4 Vulnerable groups

If minors use the bicycle, a legal guardian must give children comprehensive instruction on its use.

2.5 Personal protective equipment

Wear a suitable cycling helmet, sturdy footwear and typical close-fitting clothing to provide protection.

2.6 Safety markings and safety instructions

The bicycle nameplate contains these safety markings and safety instructions:



Symbol	Explanation
	General warning
	Adhere to the instructions for use

Table 3: Meaning of safety markings



Symbol	Explanation
	Read the instructions
	Recyclable material

Table 4: Safety instructions

2.7 What to do in an emergency

2.7.1 Dangerous situation in road traffic

- ▶ In the event of any hazards or dangers in road traffic, apply the brakes on the bicycle until it comes to a halt.

2.7.2 Leaked brake fluid

The brake system must be repaired immediately if brake fluid leaks out. Dispose of leaking brake fluid in an environmentally responsible way in accordance with statutory regulations.

- ▶ Remove those affected from the danger area to fresh air.
- ▶ Never leave those affected unattended.
- ▶ Immediately remove any clothing items contaminated with brake fluid.
- ▶ Never inhale vapours. Ensure sufficient ventilation.
- ▶ Wear gloves and safety glasses as protective equipment.
- ▶ Keep unprotected persons away.
- ▶ Take care with leaked brake fluid as it poses a slip hazard.
- ▶ Keep leaked brake fluid away from naked flames, hot surfaces and sources of ignition.
- ▶ Avoid contact with skin and eyes.

After inhalation

- ▶ Take in fresh air. Immediately consult a doctor in case of any discomfort.

After skin contact

- ▶ Wash affected skin with soap and water and rinse well. Remove contaminated clothing. Consult doctor in the event of pain or discomfort.

After contact with eyes

- ▶ Rinse eyes under flowing water for at least ten minutes with the lids open; also rinse under lids. Immediately consult a doctor in case of any pain or discomfort.

After swallowing

- ▶ Rinse out mouth with water. Never induce vomiting. Risk of aspiration!
- ▶ If a person is lying on their back and vomiting, place them in the recovery position. Seek medical advice immediately.

Environmental protection measures

- ▶ Never allow brake fluid to flow into the sewage system, water courses or groundwater.
- ▶ Notify the relevant authorities if fluid penetrates the ground, water courses or the sewage system.
- ▶ Consult a doctor immediately in the event of any pain or discomfort caused by combustion gas or leaking fluids.

2.7.3 Oil and lubricant leaks from the fork

Dispose of oils and lubricants which have leaked from the rear frame damper in an environmentally responsible way in compliance with statutory regulations.

- ▶ Contact your specialist dealer.

2.7.4 Oil and lubricant leaks from the rear frame damper

Dispose of oils and lubricants which have leaked from the rear frame damper in an environmentally responsible way in accordance with statutory regulations.

- ▶ Contact your specialist dealer.

3 Overview

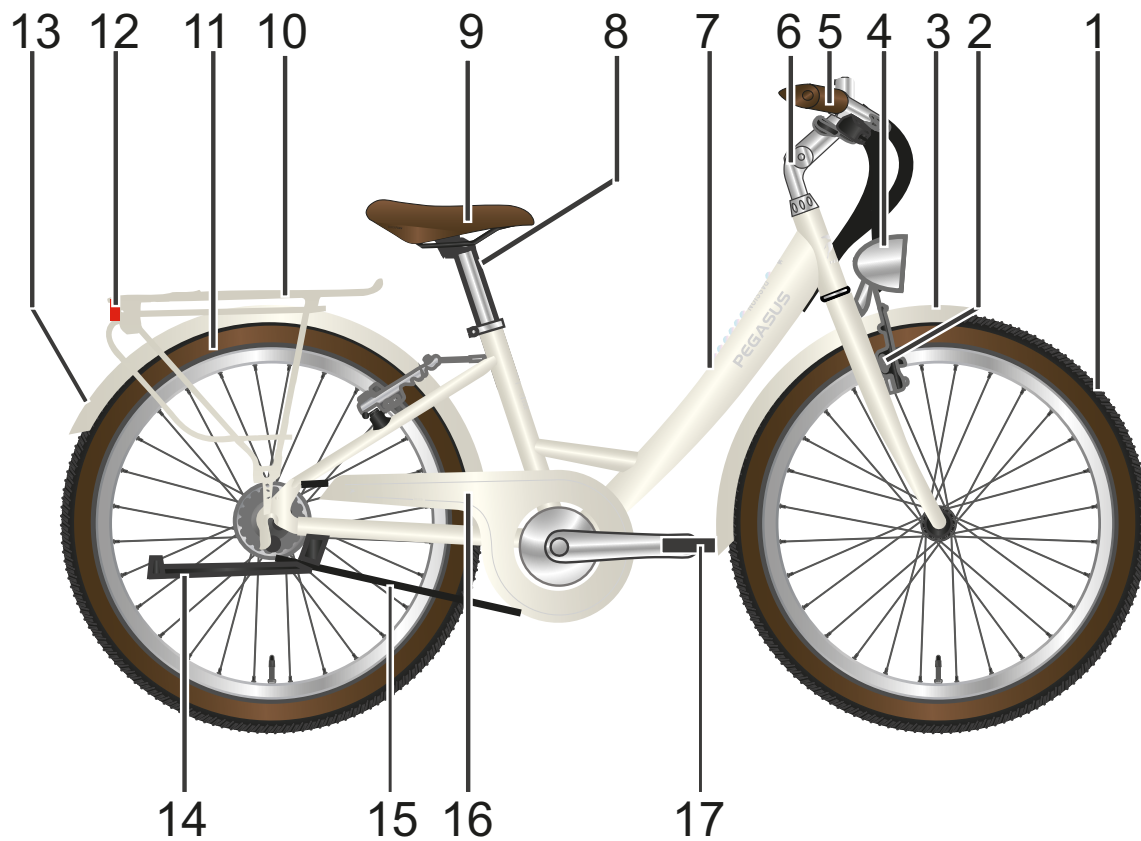

Figure 2: Bicycle viewed from the right – example

1	Front wheel	10	Pannier rack
2	Fork	11	Rear wheel
3	Front guard	12	Rear light
4	Headlight	13	Rear guard
5	Handlebars	14	Kickstand
6	Stem	15	Chain
7	Frame	16	Chain guard
8	Seat post	17	Pedal
9	Saddle		

3.1 Description

3.1.1 Wheel

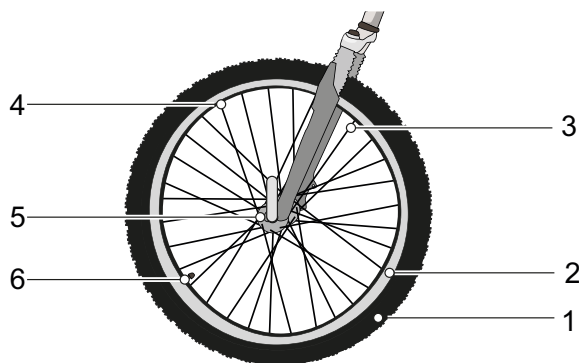

Figure 3: Visible wheel components

- | | |
|---|---------------|
| 1 | Tyres |
| 2 | Rim |
| 3 | Spoke |
| 4 | Spoke nipples |
| 5 | Hub |
| 6 | Valve |

The wheel comprises the *wheel* itself, an inner tube with a valve and a tyre.

3.1.1.1 Valve

Each wheel has a valve. It is used to fill the *tyre* with air. There is a valve cap on each valve. The screw-on valve cap keeps out dust and dirt.

The bicycle either has a classical Dunlop valve, a Presta valve or a Schrader valve.

3.1.2 Suspension

Both forks and suspension forks are fitted in this model series.

3.1.2.1 Rigid fork

Rigid forks do not feature suspension. They transfer the used muscle and motor power to the road to optimum effect. Bicycles with rigid forks consume less energy on steep roads and have a greater range than bicycles with adjusted suspension.

3.1.2.2 Suspension fork

A suspension fork is based either on a steel spring or air suspension.

Unlike a rigid fork, a suspension fork has two functions which improve floor contact and comfort: suspension and damping. The suspension prevents an impact, such as one caused by a stone lying in the bicycle's path, from being channelled directly into the rider's body via the fork. The impact is absorbed by the suspension system instead. This causes the suspension fork to compress.

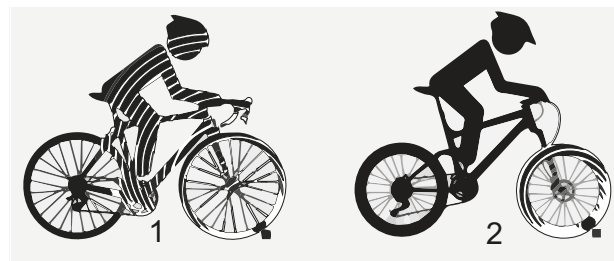

Figure 4: Without suspension (1) and with suspension (2)

After compressing, the suspension fork returns to its original position. If there is a damper, it decelerates movement, preventing the suspension system from springing back in an uncontrolled manner and stopping the fork from vibrating up and down. Dampers which dampen compressive deflection movements, i.e. a compression load, are called compression dampers or compression dashpots.

Dampers which dampen rebound deflection movements, i.e. a rebound load, are called rebound dampers or dashpots.

The compression can be disabled in any suspension fork. A suspension fork will then behave like a rigid fork.

Negative deflection

Sag is the percentage of total deflection that is compressed by the rider's weight, including equipment (such as a backpack), their seating position and frame geometry. Sag is not caused by riding.

The bicycle rebounds at a controlled speed if it is optimally adjusted. The wheel stays in contact

with the ground when passing over bumps (blue line).

The fork head, handlebars and rider broadly follow the terrain (green line) when riding over bumps. The suspension motion is predictable and controlled.



Figure 5: Optimum fork riding performance

When optimally adjusted, the fork counteracts deflection, stays higher in its deflection range and

helps the rider to maintain speed while riding on hilly parts of terrain.



Figure 6: Optimum fork riding performance on hilly terrain

When optimally adjusted, the fork deflects quickly and unhindered when the bike hits bumps and absorbs a bump. Traction is retained (blue line).

The fork responds quickly to the bump. The headset and handlebars rise slightly when absorbing a bump (green line).



Figure 7: Optimum fork riding performance over bumps

Steel suspension fork

The stem and handlebars are fastened to the fork steerer. The wheel is fastened to the axle.

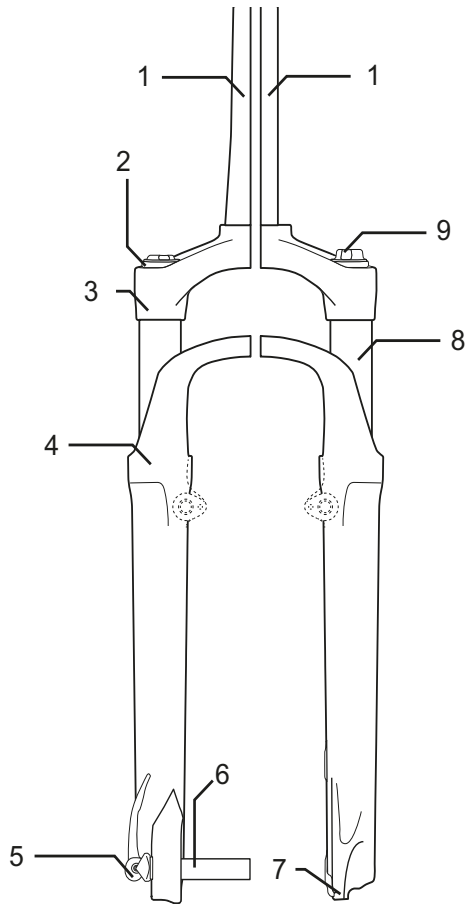

Figure 8: Suntour steel suspension fork as an example

- 1 Fork steerer
- 2 Sag setting wheel
- 3 Crown
- 4 Dust seal
- 5 Q-Loc
- 6 Axle
- 7 Fork end
- 8 Stanchion
- 9 Compression setting

Air suspension fork

The air suspension fork features an air suspension assembly (orange), a compression damper assembly (blue) and, in some cases, a rebound damper assembly (red).

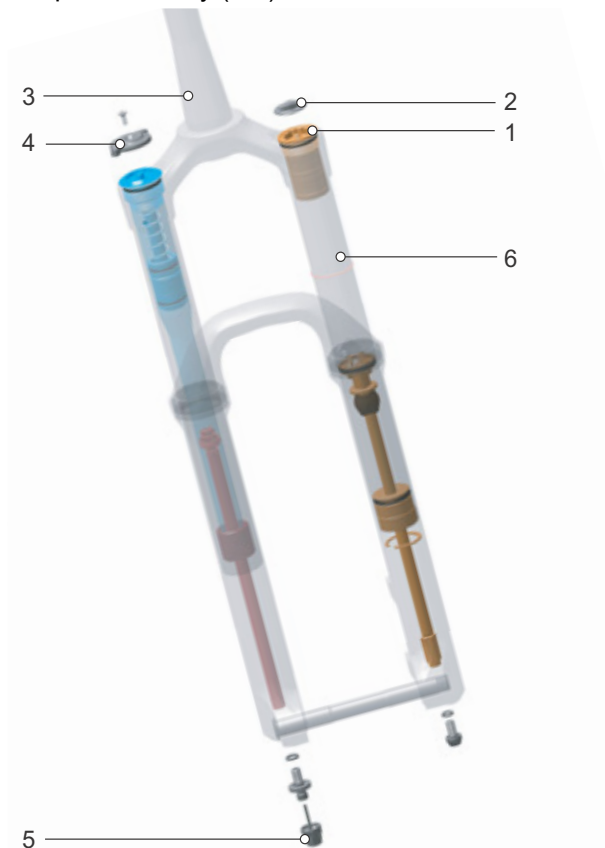

Figure 9: Example showing RockShox Lyrik Select fork

- 1 Air valve
- 2 Air valve cap
- 3 Fork steerer
- 4 Sag setting wheel
- 5 Rebound setting
- 6 Stanchion

3.1.2.3 Rear frame damper

The rear frame damper rebounds at a controlled speed if it is optimally adjusted. The rear wheel does not bounce off rough surfaces or the ground; it stays in contact with the ground instead (blue line).

the suspension deflects as soon as the wheel touches the ground after the bump. The rear frame damper rebounds in a controlled way, so that the rider remains sitting in a horizontal position when the next bump is absorbed. The suspension motion is predictable and controlled and the rider is not thrown upwards or forwards (green line).

The saddle is raised slightly if the bump is compensated and gently sinks downwards when



Figure 10: Optimum rear frame damper riding performance

When optimally adjusted, the rear frame damper counteracts deflection, stays higher in its

deflection range and helps the rider to maintain speed when riding on hilly parts of terrain.



Figure 11: Optimum rear frame damper riding performance on hilly terrain

When optimally adjusted, the rear frame damper deflects quickly and unhindered when the bike hits bumps and absorbs a bump. Traction is retained (blue line).

The saddle rises slightly when absorbing a bump (green line).



Figure 12: Optimum rear frame damper riding performance over bumps

3.1.2.4 Suntour rear frame damper

The rear frame damper features air suspension, a compression damper and a rebound damper.

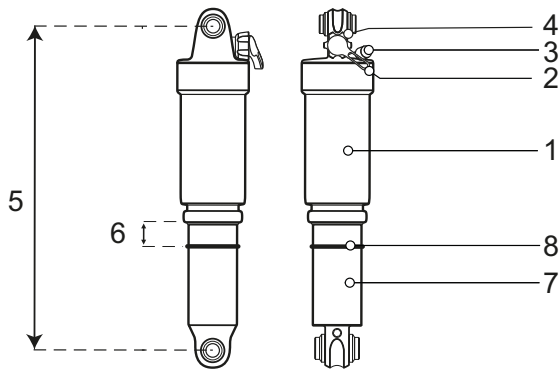

Figure 13: Example showing Suntour rear frame damper I

- 1 Air chamber
- 2 Rebound lever (rebound setting)
- 3 Air valve
- 4 Lockout lever
- 5 Total damper length
- 6 Negative deflection in the rear frame damper
- 7 Damper unit
- 8 O-ring

3.1.2.5 RockShox rear frame damper

The rear frame damper features air suspension, a compression damper and a rebound damper.



Figure 14: Monarch RL as an example

- 1 Threshold lever
- 2 Rebound damper adjuster
- 3 Air valve
- 4 O-ring
- 5 Scale
- 6 Air chamber

3.1.3 Brake system

Every bicycle has a hydraulic brake system. The brake fluid is in a closed hose system. If the rider pushes the brake lever, the brake fluid activates the brake on the wheel.

The bicycle has either:

- a rim brake on the front and rear wheels
- a disc brake on the front and rear wheels or
- a rim brake on the front and rear wheels and an additional back-pedal brake.

The mechanical brakes are used as an emergency stop system and bring the bicycle to a halt quickly and safely in the event of an emergency.

3.1.3.1 Rim brake

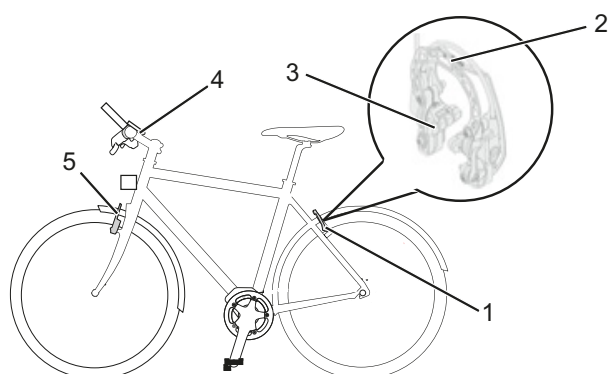

Figure 15: Brake system with rim brake in detail – Magura HS22 used as an example

- 1 Rear wheel rim brake
- 2 Brake booster
- 3 Brake lining
- 4 Handlebars with brake lever
- 5 Front wheel rim brake

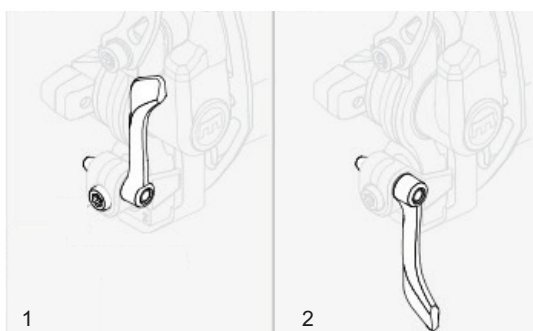

Figure 16: Rim brake locking lever, closed (1) and open (2)

The rim brake stops the wheel moving when the rider pushes the *brake lever*, causing two brake linings, positioned opposite one another, to be pressed onto the *rims*. The hydraulic rim brake features a locking lever. The rim brake locking lever is not marked with any lettering. Only a specialist dealer may set the rim brake locking lever.

3.1.3.2 Disc brake

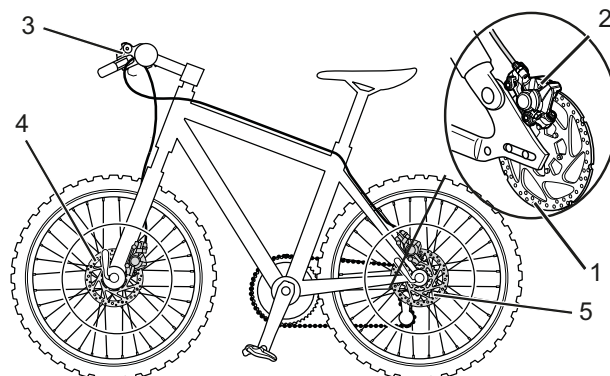

Figure 17: Brake system with disc brake – example

- 1 Brake disc
- 2 Brake calliper with brake linings
- 3 Handlebars with brake lever
- 4 Front wheel brake disc
- 5 Rear wheel brake disc

On a bicycle with a disc brake, the brake disc is screwed permanently to the *hub* of the wheel.

The *brake lever* is pushed to increase brake pressure. The brake fluid is used to transfer pressure through the brake cables to the cylinders in the brake calliper. The braking force is boosted by a speed reduction and applied to the brake linings. These apply the brake disc mechanically. If the *brake lever* is pushed, the brake linings are pressed against the brake disc and the wheel movement is decelerated until it comes to a stop.

3.1.3.3 Back-pedal brake



Figure 18: Brake system with a back-pedal brake – example

- 1 Rear wheel rim brake
- 2 *Handlebars with brake lever*
- 3 Front wheel rim brake
- 4 *Pedal*
- 5 Back-pedal brake

The back-pedal brake stops the movement of the rear wheel when the rider pedals in the opposite direction to the direction of travel.

3.1.4 Drive system

The bicycle is driven by muscle power via the chain drive. The force which is applied by pedalling in the direction of travel drives the front chain wheel. The chain transmits the force onto the rear chain wheel and then onto the rear wheel.

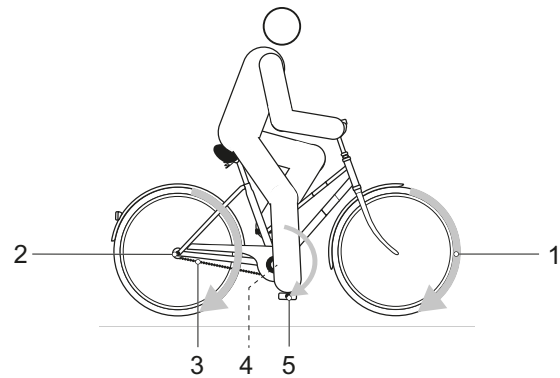

Figure 19: Diagram of mechanical drive system

- 1 Direction of travel
- 2 Chain
- 3 Rear chain wheel
- 4 Front chain wheel
- 5 Pedal

3.2 Proper use

The bicycle may only be used in a perfect, fully functional condition. National requirements may apply to the bicycle which differ from the standard equipment. For riding on public roads, some special regulations apply in relation to the riding light, reflectors and other components.

The general laws and the regulations for the prevention of accidents and environmental

protection in the respective country of use must be adhered to. All check lists and instructions for actions in these *instructions* must be observed. Approved accessories can be installed by specialist staff.

Each bicycle is assigned a bicycle type, which determines its proper use, function and area of use.







City and trekking bicycles	Child's bicycles/ bicycles for young adults	Mountain bikes	Racing bicycle	Cargo bike	Folding bicycle
					
<p>City and trekking bicycles are designed for daily, comfortable use. They are suitable for riding on public roads.</p>	<p>The legal guardians of minor riders must read and understand these <i>instructions</i> before commissioning.</p> <p>The content of these <i>instructions</i> must be communicated to the riders in an age-appropriate manner.</p> <p>The cycles for children and young adults are suitable for riding on public roads. The size of the cycle must be checked regularly for orthopaedic reasons.</p> <p>A check must be made at least every three months to make sure that the maximum permitted total weight is being observed.</p>	<p>Mountain bikes are designed for sporting use. The design characteristics include a short wheelbase, a sitting position with the rider inclined towards the front, and a brake requiring low actuation force.</p> <p>A mountain bike is a piece of sporting equipment. It requires an adaptation period and the rider must be physically fit. Use requires the appropriate training; in particular riding in bends and braking should be practised.</p> <p>The strain on the rider, in particular the hands and wrists, arms, shoulders, neck and back, is accordingly high. Inexperienced riders tend to brake excessively and lose control as a result.</p>	<p>A racing bicycle is designed for fast rides on roads and paths with a good, undamaged road surface.</p> <p>A racing bicycle is a piece of sporting equipment and not a means of transport. A racing bicycle is characterised by its lightweight structure and a design which is stripped to the minimum parts required for riding.</p> <p>The frame geometry and the layout of the operating elements are designed in such a way that the bicycle can be ridden at high speeds. The frame design requires practice to ensure the rider is able to ride slowly, apply the brakes and get on and off the bike safely.</p> <p>The sitting position is athletic. The strain on the rider, in particular the hands and wrists, arms, shoulders, neck and back, is accordingly high. The sitting position therefore requires physical fitness.</p>	<p>The cargo bike is suitable for daily transportation of loads on public roads.</p> <p>The transportation of loads requires skill and physical fitness in order to balance the additional weight. The very varied loading conditions and weight distributions require special practice and skill when braking and riding in bends.</p> <p>A longer period is required to adaptation to the length, width and turning circle. You need to be cautious when riding a cargo bike. You must pay attention to the traffic on public roads and the condition of the route accordingly.</p>	<p>The folding bicycle is suitable for use on public roads.</p> <p>A folding bicycle can be folded up and is thus suitable for space-saving transportation, for example on public transport or in a car.</p> <p>The folding function of the folding bicycle makes it necessary to use smaller wheels and longer brake cables and Bowden cables. Therefore, in case of an increased load, a reduction in riding stability and braking power, diminished comfort and reduced durability are to be expected.</p>

Table 5: Proper use for each bicycle type

3.3 Improper use

Failure to adhere to the proper use poses a risk of personal injury and material damage. It is prohibited to use the bicycle in the following ways:

- riding with a damaged or incomplete bicycle
- riding over steps
- carrying other people
- riding with excessive baggage
- riding with no hands
- riding on ice and snow without winter accessories
- improper servicing
- improper repair
- tough areas of use, such as professional competitions
- stunt riding or acrobatics.

City and trekking bicycles	Child's bicycles/ bicycles for young adults	Mountain bikes	Racing bicycle	Cargo bike	Folding bicycle
					
City and trekking bicycles are not sports bicycles. If used for sports, the rider can expect reduced riding stability and diminished comfort	Cycles for children and young adults are not toys.	Mountain bikes must be retrofitted with lighting, a bell and other fittings as specified by national laws and regulations before they are used on public roads.	Racing bikes must be retrofitted with lighting, a bell and other fittings as specified by national laws and regulations before they are used on public roads.	A cargo bike is not a touring bicycle or a sports bicycle.	The folding bicycle is not a sports bicycle.

Table 6: Information on improper use

3.4 Technical data

3.4.1 Bicycle

Transportation temperature	-10 °C - 50 °C
Ideal transportation temperature	22 °C - 26 °C
Storage temperature	-10 °C - 50 °C
Ideal storage temperature	10 °C - 15 °C
Operating temperature	0 °C - 30 °C
<i>Work environment</i> temperature	15 °C - 25 °C

Table 7: Bicycle technical data

3.4.2 Tightening torque

Axle nut tightening torque	35 Nm - 40 Nm
Handlebars clamping screw maximum tightening torque*	5 Nm - 7 Nm

Table 8: Tightening torque values

*If the specifications on the component itself do not state otherwise

3.5 Description of controls and screens

3.5.1 Handlebars

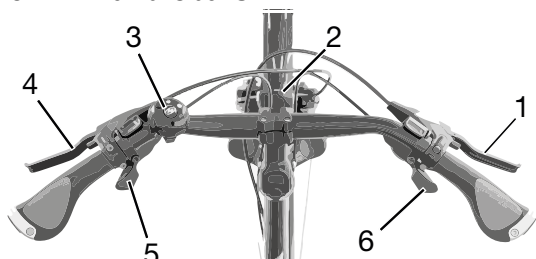

Figure 20: Detailed view of bicycle from rider position

- 1 Rear brake lever
- 2 Headlight
- 3 Bell
- 4 Front brake lever
- 5 Shifter
- 6 Shifter

3.6 Environmental requirements

You can ride the bicycle within a temperature range between 0 °C and 30 °C.

Optimal operating temperature	22 °C - 26 °C
--------------------------------------	---------------

Temperatures under -10 °C and over +35 °C must be avoided.

The bicycle must be equipped with accessories for winter use if temperatures fall below 0 °C.

You must keep within the following temperature ranges.

Transportation temperature	-10 °C - 50 °C
Storage temperature	-10 °C - 50 °C
<i>Work environment</i> temperature	15 °C - 25 °C











Table 9: Bicycle technical data

The nameplate contains symbols for the bicycles' area of use. Before the first ride, the rider needs to check which paths and roads the bicycle is safe to ride on.

Area of use	City and trekking bicycles	Child's bicycles/ bicycles for young adults	Mountain bikes	Racing bicycle	Cargo bike	Folding bicycle
1						
Suitable for tar-macked and paved roads.	Suitable for tar-macked and paved roads.	Suitable for tar-macked roads, cycle paths and firm gravel paths and roads, and longer sections with moderate slopes and jumps up to 15 cm.	Suitable for tar-macked roads, cycle paths and easy to demanding off-road riding, sections with moderate slopes and jumps up to 61 cm.	Suitable for tar-macked roads, cycle paths and firm gravel paths and roads, and longer sections with moderate slopes and jumps up to 15 cm.		
2			Suitable for tar-macked roads, cycle paths and easy to demanding off-road riding, limited downhill use and jumps up to 122 cm.			
3			Suitable for tar-macked roads, cycle paths and easy to extremely difficult off-road riding, unlimited downhill use and any jumps.			
4						

Table 10: Area of use

The bicycle is unsuitable for the following areas of use:

Area of use	City and trekking bicycles	Child's bicycles/ bicycles for young adults	Mountain bikes	Racing bicycle	Cargo bike	Folding bicycle
						
 1	Never drive off-road or perform jumps.	Never drive off-road or perform jumps.		Never drive off-road or perform jumps.	Never drive off-road or perform jumps.	Never drive off-road or perform jumps.
 2	Never drive off-road or perform jumps over 15 cm.	Never drive off-road or perform jumps over 15 cm.	Never drive off-road or perform jumps over 15 cm.	Never drive off-road or perform jumps over 15 cm.		
 3			Never ride downhill or perform jumps over 61 cm.			
 4			Never traverse extremely difficult off-road terrain or perform jumps over 122 cm.			

4 Transporting and storing



4.1 Shipment

- ▶ When shipping the bicycle, we recommend that you have the specialist dealer partially dismantle the bicycle and place it in the proper packaging.

4.2 Transportation

- ▶ Take into account the ready-to-use bicycle's weight when transporting it.
- ▶ Transport the bicycle in a dry, clean position where it is protected from direct sunlight.

4.2.1 Using the brake transport securing system

Only applies to bicycles with disc brakes



Oil leak if no transport securing device

The brake securing device prevents the brakes from being applied accidentally during transportation or shipment. This could cause irreparable damage to the brake system or an oil leak, which will harm the environment.

- ▶ Never push the brake lever when the wheel has been dismantled.
- ▶ Always use the transport securing system when transporting or shipping.

- ▶ Insert the **transport securing devices** between the brake linings.
- ⇒ Transport securing device is squeezed between the two linings and prevents undesired sustained braking which can cause brake fluid to leak out.

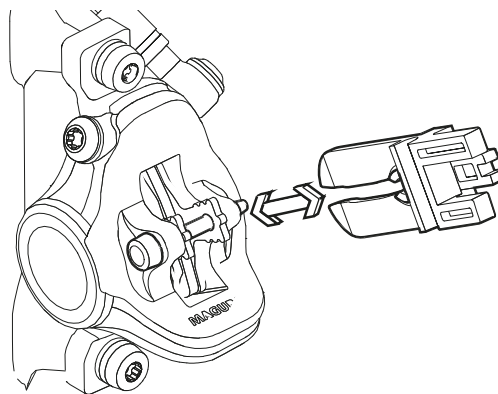

Figure 21: Fastening the transport securing device

4.3 Storing

- ▶ Store the bicycle in a clean, dry place where it is protected from direct sunlight. Do not store outdoors to ensure a long service life. Temperatures under $-10\text{ }^{\circ}\text{C}$ or over $+50\text{ }^{\circ}\text{C}$ must generally be avoided. Storage at about $20\text{ }^{\circ}\text{C}$ is beneficial to a long service life.



5 Assembly



WARNING

Risk of eye injury

Problems may arise if the settings are not made to components correctly and you may sustain serious injuries as a result.

- ▶ Always wear safety glasses to protect your eyes during assembly.

- ✓ Assemble the bicycle in a clean and dry environment.
- ✓ The *work environment* temperature should be between 15 °C and 25 °C.
- ✓ The fitting stand used must be approved for a maximum weight of at least 30 kg.

5.1 Required tools

The following tools are required to assemble the bicycle:

- Knife
- Hexagon socket spanner 2 (2.5 mm, 3 mm, 4 mm, 5 mm, 6 mm and 8 mm)
- Torque wrench with working range between 5 and 40 Nm
- Twelve-point square socket T25
- Ring spanner (8 mm, 9 mm, 10 mm), 13 mm, 14 mm and 15 mm) and
- Cross, flat head and ordinary screwdriver.

5.2 Unpacking

The packaging material consists mainly of cardboard and plastic film.

- ▶ The packaging has to be disposed of in accordance with the regulations of the authorities.

5.2.1 Scope of delivery

The bicycle is fully assembled in the factory for test purposes and then dismantled for transportation.

The bicycle is 95–98 % pre-assembled. The scope of delivery includes:

- the pre-assembled bicycle
- the front wheel
- the pedals
- quick release (optional)
- the charger
- the *instructions*.

5.3 Commissioning

Only trained specialist staff may perform initial commissioning since initial commissioning of the bicycle requires special tools and specialist knowledge.

Experience has shown that a bicycle which has not yet been sold is automatically handed to customers as soon as it appears ready to ride.

- ▶ For this reason, every bicycle must be prepared, so it is fully ready for use immediately after being assembled.
- ▶ The assembly report (see Section [11.2](#)) describes all safety-relevant inspections, tests and maintenance tasks. All assembly work must be completed to ensure the bicycle is ready to ride.
- ▶ Complete an assembly report for quality assurance purposes.

5.3.1 Installing the wheel in the Suntour fork

5.3.1.1 Screw-on axle (15 mm)

Only applies to Suntour forks with 15 mm screw-on axle

1 Insert the axle completely on the drive side.

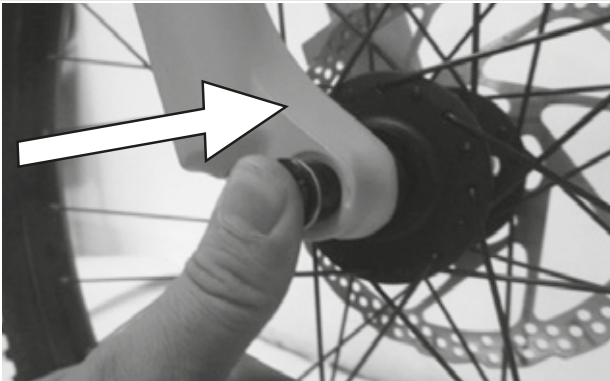

Figure 22: Fully inserting the axle

2 Tighten the axle to 8–10 Nm with a 5 mm hexagon socket spanner.

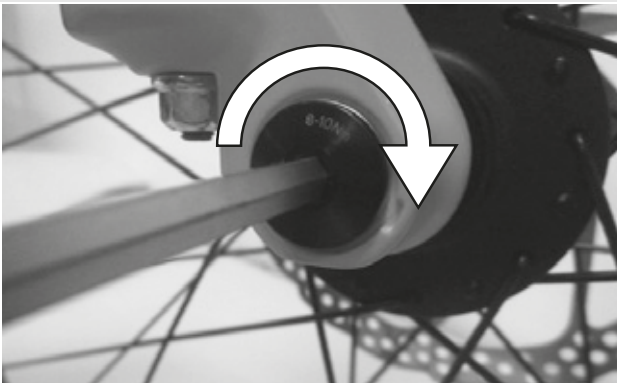

Figure 23: Tightening the axle

3 Insert the securing screw on the non-drive side.



Figure 24: Pushing the quick release lever into the axle

4 Tighten the securing screw with a 5 mm hexagon socket spanner to 5–6 Nm.

⇒ The lever is mounted.

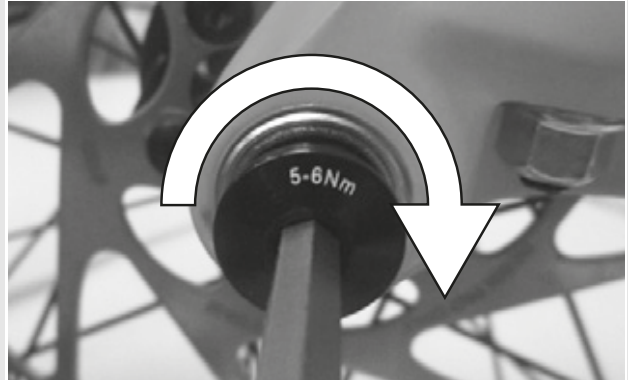

Figure 25: Tightening the securing screw

5.3.1.2 Screw-on axle (20 mm)

Only applies to Suntour forks with 20 mm screw-on axle

1 Insert the axle completely on the drive side.



Figure 26: Tightening the inserted axle

2 Tighten the securing clip with a 4 mm hexagon socket spanner to 7 Nm.



Figure 27: Tightening the securing clip

5.3.1.3 Quick release axle

Only applies to Suntour forks with screw-on axle

CAUTION

Crash caused by loose quick release axle

A faulty or incorrectly installed quick release axle may become caught in the brake disc and block the wheel. This will cause a crash.

- ▶ Never fit a defective quick release axle.

Crash caused by faulty or incorrectly installed quick release axle

The brake disc becomes very hot during operation. Parts of the quick release axle may become damaged as a result. The quick release axle becomes loose. This will cause a crash with injuries.

- ▶ The quick release axle and the brake disc must be opposite one another.

Crash caused by incorrectly set quick release axle

Insufficient clamping force will result in unfavourable transmission of force. The suspension fork or the quick release axle may break. This will cause a crash with injuries.

- ▶ Never fasten a quick release axle with a tool, such as a hammer or pliers.

1 Insert the axle into the hub on the drive side.

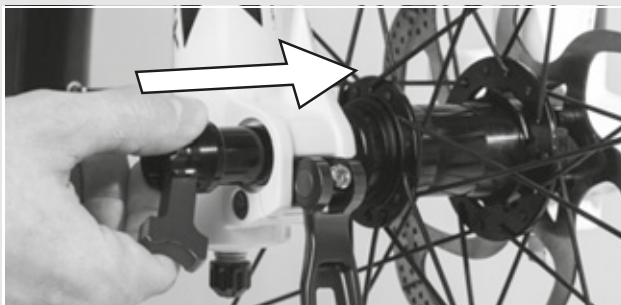

Figure 28: Pushing the axle into the hub

2 Tighten the axle with the red handle.

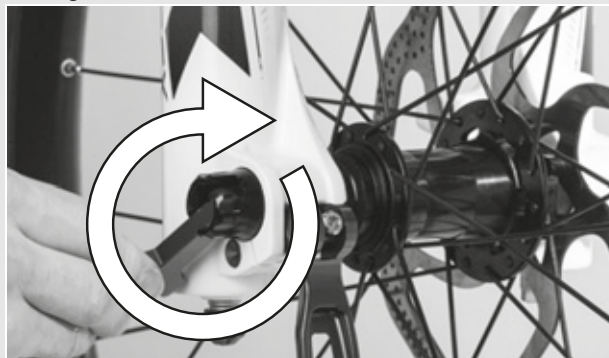

Figure 29: Tightening the axle

3 Push the quick release lever into the axle.

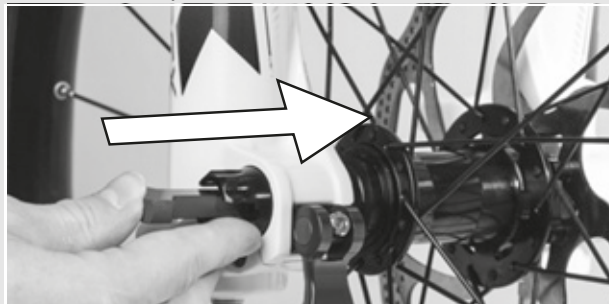

Figure 30: Pushing the quick release lever into the axle

4 Turn the quick release lever.

⇒ The lever is secured.



Figure 31: Securing the lever

- 5 Check the position and clamping force of the quick release lever. The quick release lever must be flush with the lower housing. You must be able to see a slight impression on the palm of your hand when you close the quick release lever.



Figure 32: Perfect position for the clamping lever

- 6 Use 4 mm hexagon socket spanner to adjust the clamping lever clamping force if required.
- 7 Check the quick release lever position and clamping force.

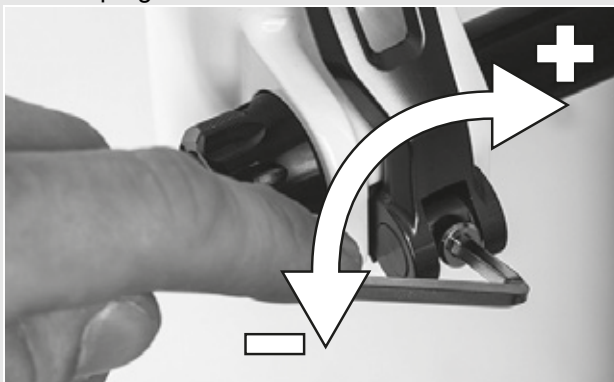

Figure 33: Adjusting the quick release clamping force

5.3.1.4 Quick release

Only applies to Suntour forks with quick release

CAUTION

Crash caused by unfastened quick release

A faulty or incorrectly installed quick release may become caught in the brake disc and block the wheel. This will cause a crash.

- ▶ Never fit a defective quick release.

Crash caused by faulty or incorrectly installed quick release

The brake disc becomes very hot during operation. Parts of the quick release may become damaged as a result. The quick release comes loose. This will cause a crash with injuries.

- ▶ The front wheel quick release lever and the brake disc must be situated on opposite sides.

Crash caused by incorrectly set clamping force

Excessively high clamping force will damage the quick release and cause it to lose its function.

Insufficient clamping force will result in unfavourable transmission of force. The suspension fork or the quick release may break. This will cause a crash with injuries.

- ▶ Never fasten a quick release using a tool (e.g. hammer or pliers).
- ▶ Only use the clamping lever with the specified set clamping force.

- 1 Before installing, ensure that the quick release flange is extended. Open the lever fully.

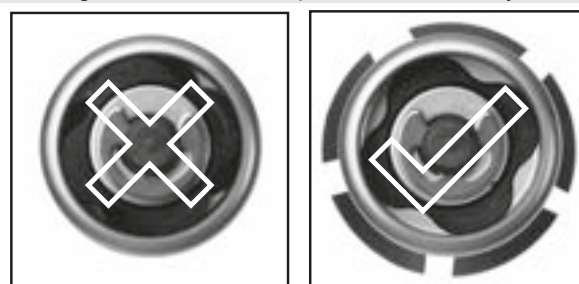

Figure 34: Open and closed flange

- 2 Push in the quick release until you can hear a click. Make sure that the flange is extended.



Figure 35: Pushing the quick release in

- 3 Adjust tensioning with half-open clamping lever until the flange reaches the fork end.

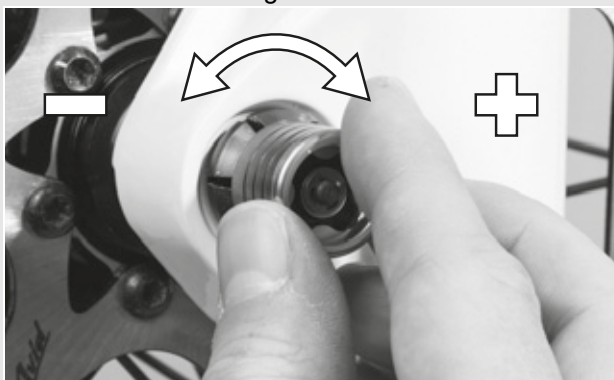

Figure 36: Adjusting the clamping

- 4 Fully close the quick release. Check that the quick release is firmly in place and adjust it on the flange if necessary.

⇒ The lever is secured.



Figure 37: Closing the quick release

5.3.2 Installing the wheel in the FOX fork

5.3.2.1 Quick release (15 mm)

Only applies to FOX forks with 15 mm screw-on axle

The procedure for installing the 15 x 100 mm and 15 x 110 mm quick releases is the same.

- 1 Place the front wheel in the fork ends of the fork. Push the axle through the fork end on the non-drive side and hub.

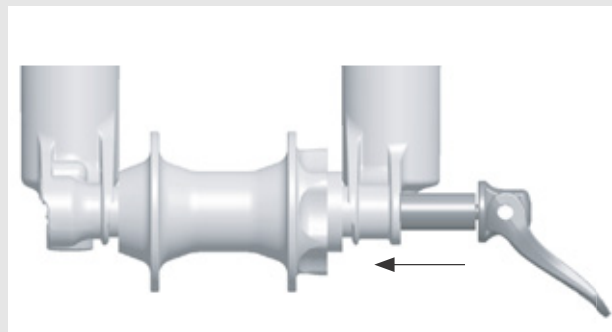

Figure 38: Pushing the quick release in

- 2 Open the axle lever.
- 3 Turn the axle five to six complete revolutions clockwise into the axle nut.
- 4 Close the quick release lever. The lever must be tensioned to the point that it leaves a mark on your hand.
- 5 The lever must be 1 to 20 mm ahead of the fork leg in the closed position.

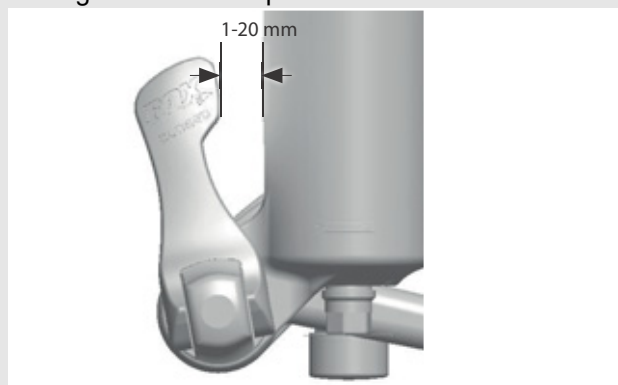

Figure 39: Spacing between lever and fork leg

⇒ The quick release must be adjusted if the lever is tensioned inadequately or too strongly when closed in the recommended position (1 to 20 mm in front of the fork).

Setting the quick releases

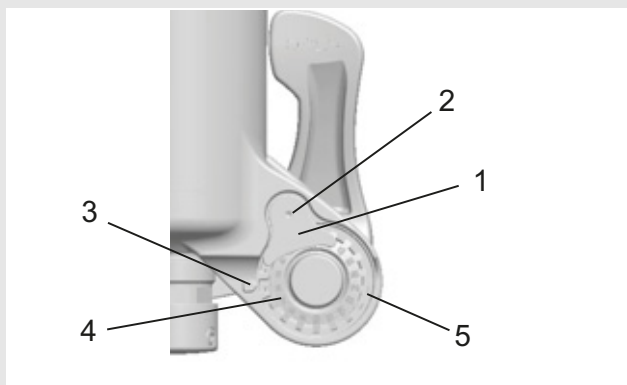

Figure 40: Structure of quick release from rear with (1) axle nut lock and (5) axle nut

- 1 Record the axle setting value (4) indicated by the directional arrow (3).
- 2 Loosen the axle nut securing screw (2) with a 2.5 mm hex key by approx. four revolutions, but do not remove the screw completely.
- 3 Turn the quick release lever to the open position and loosen the axle by approx. four revolutions.
- 4 Press the axle inward from the side of the open lever. This pushes out the axle nut securing screw so that you can turn it out of the way.
- 5 Push the axle further forward and turn the axle nut clockwise to increase the lever tension or anti-clockwise to reduce the lever tension.
- 6 Reinsert the axle nut lock and tighten the screw to 0.9 Nm (8 in-lb).
- 7 Repeat the steps for installing the axle to check proper installation and correct adjustment.

5.3.2.2 Kabolt axle

Only applies to FOX forks with Kabolt axles

The same procedure is used for installing both the 15 x 100 mm and 15 x 110 mm Kabolt axles.

- 1 Place the front wheel in the fork ends of the fork. Push the Kabolt axle through the fork end on the non-drive side and hub.

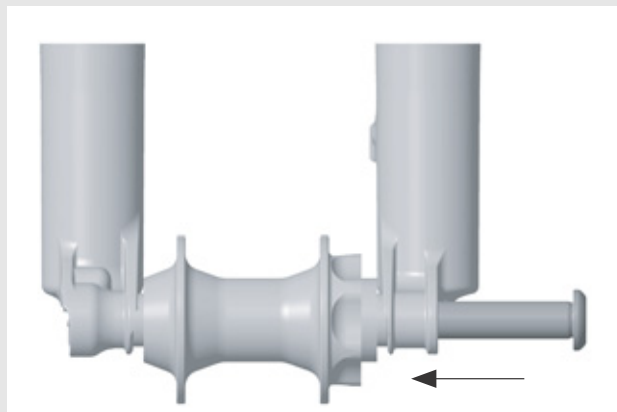

Figure 41: Pushing the Kabolt axle in

- 2 Tighten the Kabolt axle screw to 17 Nm (150 in-lb) with a 6 mm hex key.

5.3.3 Checking the stem and handlebars

5.3.3.1 Checking the connections

- 1 Stand in front of the bicycle to check whether the handlebars, stem and fork steerer are firmly attached to one another. Clamp the front wheel between your legs. Grasp the handlebar grips.
 - 2 Try to twist the handlebars towards the front wheel.
- ⇒ The stem must not move or twist.

5.3.3.2 Firm hold

- 1 Place your entire body weight on the handlebars with the quick release lever closed to check that the stem is firmly in place.
⇒ The handlebars shaft must not move downwards in the fork steerer.
- 2 If the handlebars shaft should move in the fork steerer, increase the quick release lever tensioning. To do so, turn the knurled nut slightly clockwise with the quick release lever open.
- 3 Close the lever and check the stem is firmly in position.

5.3.3.3 Checking the headset backlash

- 1 To check the handlebar headset backlash, close the quick release lever on the stem.
- 2 Place the fingers of one hand on the upper headset cup. Pull the front wheel brake with the other hand and try to push the bicycle backwards and forwards.
- 3 The headset cup halves must not move towards one another while you are doing this. Note that there may be noticeable backlash due to worn-out bearing bushes or brake lining backlash in suspension forks and disc brakes.
- 4 If there is headset backlash in the steering headset, you must adjust it as soon as possible; otherwise, the headset will become damaged. You must make the adjustment as described in the stem manual.

5.4 Selling the bicycle

- ▶ Complete bike pass on the cover of the instructions.
- ▶ Adjust the bicycle to the rider; see Section 6.5.
- ▶ Set the stand and the shifter if necessary.

6 Operation

6.1 Risks and hazards

WARNING

Injuries and death caused by other road users

Other road users such as buses, trucks, cars or pedestrians often underestimate the speed of bicycles. Such road users frequently do not even see bicycles. This may cause a crash with serious injuries or even death.

- ▶ Wear a cycling helmet and high-visibility, reflective clothing.
- ▶ Always take a defensive approach to riding.
- ▶ Avoid the blind spots of vehicles turning off. Reduce speed as a precaution when other road users turn right.

CAUTION

Crash caused by material fatigue

Intensive use can cause material fatigue. A component may suddenly fail in case of material fatigue. This may cause a crash with injuries.

- ▶ Remove the bicycle from service immediately if there are any signs of material fatigue. Have the specialist dealer check the state.
- ▶ Have the specialist dealer carry out a basic inspection regularly. Carbon becomes brittle when exposed to heat radiation such as heating. This can cause the carbon part to break and result in a crash with injuries.
- ▶ Never expose carbon parts to strong heat sources.

CAUTION

Crash caused by poor road conditions

Loose objects, such as branches and twigs, may become caught in the wheels and cause a crash with injuries.

- ▶ Be aware of the road conditions.
- ▶ Ride slowly and brake in good time.

The *tyres* may slip on wet roads. In wet conditions you must also expect a longer braking distance. The braking sensation differs from the usual sensation. This can cause loss of control or a crash, which may result in injuries.

- ▶ Ride slowly and brake in good time when it is raining.

Crash caused by loose clothing

Shoe laces, scarves and other loose items may become entangled in the spokes on the *wheels* and on the *chain drive*. This may cause a crash with injuries.

- ▶ Wear sturdy footwear and close-fitting clothing.

Crash caused by difficult-to-spot damage

If the bicycle topples over or you have a fall or an accident, there may be difficult-to-spot damage to components such as the brake system, quick releases or *frame*. This may cause a crash with injuries.

- ▶ Take the bicycle out of service and have a specialist dealer carry out an inspection.

Crash caused by soiling

Heavy soiling can impair the functions of the bicycle, for example, the function of the brakes. This may cause a crash with injuries.

- ▶ Remove coarse soiling before riding.

Notice

Heat or direct sunlight can cause the *tyre pressure* to increase above the permitted maximum pressure. This can destroy the *tyres*.

- ▶ Never park the bicycle in the sun.
- ▶ On hot days, regularly check the *tyre pressure* and adjust it as necessary.

Moisture penetrating at low temperatures may impair individual functions due to the open structural design.

- ▶ Always keep the bicycle dry and free from frost.
- ▶ If the bicycle is to be used at temperatures below 3 °C, the specialist dealer must carry out an inspection and prepare it for winter use.

Off-road riding subjects the joints in the arms to severe strain. Take a break from riding every 30 to 90 minutes, depending on the road surface conditions and your physical fitness

6.2 Personal protective equipment

It is recommended that you wear a suitable cycling helmet, sturdy footwear and typical, close-fitting, reflective sports clothing.

6.3 Instruction and customer service

Your supplying specialist dealer will provide customer service. Contact details can be found on the bike pass for these instructions. The specialist dealer will explain all the bicycle functions to you in person, this being when the specialist dealer hands over the bicycle at the latest. These instructions are provided to you with every bicycle, so that you can consult them at a later stage.

Your specialist dealer will also be happy to assist you in the future whether you require maintenance, conversion or repair.

6.4 Adjusting the bicycle



Crash caused by incorrectly adjusted torques

If a screw is fastened too tightly, it may break. If a screw is not fastened enough, it may loosen. This will cause a crash with injuries.

- ▶ Always observe the indicated torques on the screw or in the *instructions*.

Only a correctly adjusted bicycle will guarantee the desired ride comfort and health-promoting activity. Therefore, adjust the *saddle*, the *handlebars* and the *suspension* to your body and your preferred riding style before the first ride.

6.4.1 Adjusting the saddle

6.4.1.1 Adjusting the saddle tilt

The saddle tilt must be adjusted to the seat height, the saddle and handlebar position, and the saddle shape to ensure an optimum fit. The seating position can be optimised in this way if needed. First adjust the handlebars, then the saddle.

- ▶ Adjust the saddle tilt to horizontal.

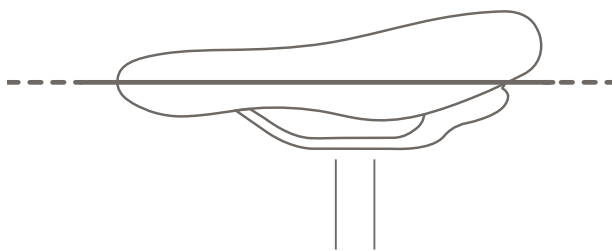

Figure 42: Horizontal saddle tilt

6.4.1.2 Determining the seat height

- ✓ To adjust the seat height safely, either
 - push the bike near to a wall, so that the rider can lean on the wall to support themselves or
 - ask another person to hold the bicycle.

1 Climb onto the bicycle.

2 Place your heel on the pedal and extend your leg, so that the pedal is at the lowest crank rotation point.

- ⇒ The rider sits straight on the saddle if the seat is at an optimum height. If this is not the case, adjust the length of the seat post to your needs.

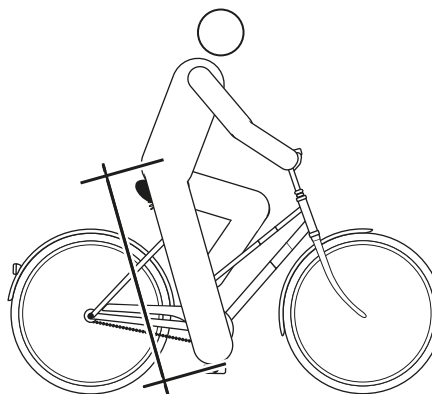

Figure 43: Optimal saddle height

6.4.1.3 Adjusting the seat height with quick release

- 1 Open the quick release on the seat post to change the seat height (1). To do so, push the clamping lever away from the seat post (3).

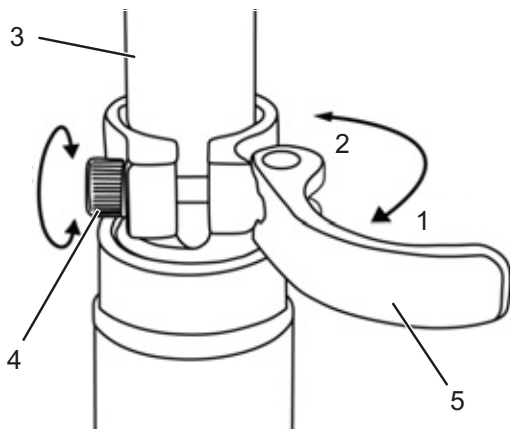

Figure 44: Opening the seat post quick release

- 2 Set the seat post to the required height.



Crash caused by an excessively high seat post setting

A seat post which is set too high will cause the seat post or the frame to break. This will cause a crash with injuries.

- ▶ Do not pull the seat post out of the frame beyond the minimum insertion depth marking.

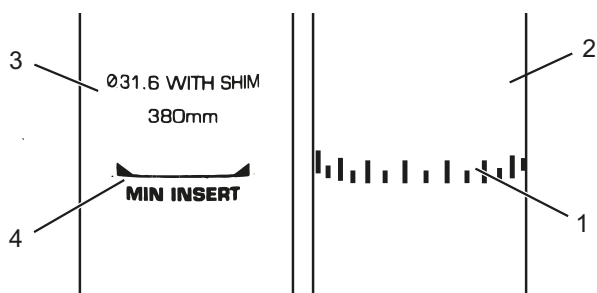

Figure 45: Detailed view of the seat post – examples of the minimum insertion depth marking

- 3 To close it, push the seat post clamping lever as far as it will go into the seat post (2).
- 4 Check the clamping force of quick releases.

6.4.1.4 Adjusting the seat position

The saddle can be shifted on the saddle frame. The right horizontal position ensures an optimal leverage position for legs. This prevents knee pain and painful incorrect pelvis positions. If you have displaced the saddle more than 10 mm, you need to adjust the saddle height again since both settings affect one another.

- ✓ To adjust the seat position safely, either push the bicycle near to a wall, so that you can lean on the wall to support yourself or ask another person to hold the bicycle for you.

- 1 Climb onto the bicycle.
- 2 Place the pedals into the vertical position with your feet.

The rider is sitting in the optimal sitting position if the perpendicular line from the kneecap runs through the pedal axle.

- 3.1 If the perpendicular line crosses behind the pedal, bring the saddle further forward.
- 3.2 If the perpendicular line crosses in front of the pedal, bring the saddle further back.
- 4 Move the saddle within its permitted displacement range only (marked on the saddle stay).

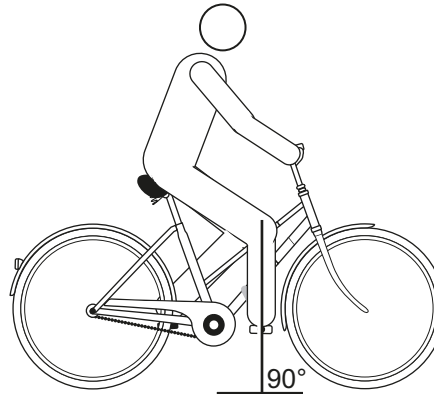

Figure 46: Knee cap perpendicular line

- ✓ The handlebar settings must only be adjusted while the bicycle is stationary.
- ▶ Unfasten and adjust the designated screw connections, and clamp them with the maximum tightening torque for the clamping screws of the handlebars.

6.4.2 Adjusting the handlebars

CAUTION

Crash caused by incorrectly set clamping force

Excessively high clamping force will damage the quick release and cause it to lose its function. Insufficient clamping force will result in unfavourable transmission of force. This can cause components to break. This will cause a crash with injuries.

- ▶ Never fasten a quick release using a tool (e.g. hammer or pliers).
- ▶ Only use the clamping lever with the specified set clamping force.

6.4.3 Adjusting the stem

CAUTION

Crash caused by loose stem

Incorrectly fastened screws may come loose due to impact. The stem may no longer be firmly fixed in its position as a result. This will cause a crash with injuries.

- ▶ Check the handlebars and the quick release system are firmly in position after the first two hours of riding.

6.4.3.1 Adjusting the height of the handlebars

- 1 Open the stem clamping lever.

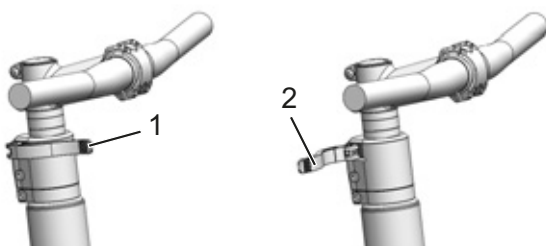

Figure 47: Open (2) and closed (1) stem clamping lever; All Up used as an example

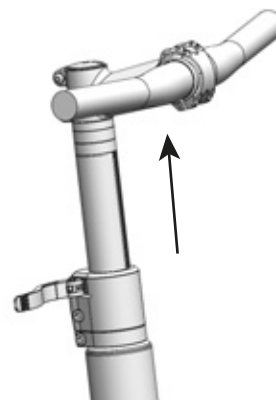

Figure 48: Pulling the locking lever upwards; All Up used as an example

- 2 Pull out the handlebars to the required height. Observe minimum insertion depth.
- 3 Close the stem clamping lever.

6.4.3.2 Adjusting the quick release clamping force

- ▶ If the *handlebar clamping lever* stops before reaching its end position, unscrew the *knurled nut*.
- ▶ Tighten the *knurled nut* on the seat post if the *seat post clamping lever's* clamping force is not effective enough.
- ▶ If you are unable to set the clamping force, the specialist dealer will need to check the quick release.

6.4.4 Adjusting the brake

The brake lever grip distance can be adjusted to ensure that it can be reached more easily. The pressure point can also be adjusted to the rider's preferences.

Contact your specialist dealer if there is no description of your brake below.

6.4.5 Retracting the brake linings

Disc brakes require wearing-in time. The braking force increases over time. You therefore need to be aware that the braking force may increase during the wearing-in period. The same happens after brake pads or discs are replaced.

- 1 Accelerate bicycle to about 25 km/h.
- 2 Brake bicycle until it comes to a halt.
- 3 Repeat process 30–50 times.

The disc brake is retracted and provides optimal braking power.

6.4.5.1 Setting the grip distance on a Magura HS33 brake lever

Only applies to bicycles with this equipment

You can adjust the brake lever position (grip distance) to your requirements. Such adjustment does not affect the pressure point or the position of the brake linings.

- ✓ Use a T25 TORX® wrench to turn the setting screw (1) to adjust the grip distance.

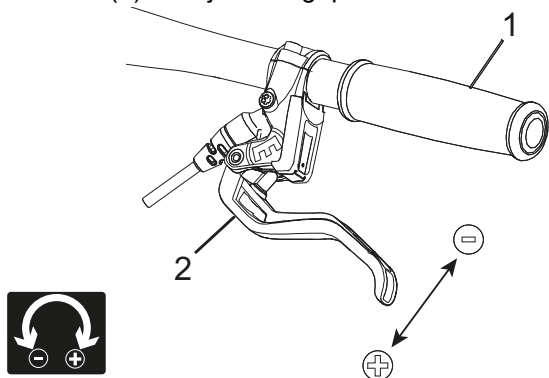

Figure 49: Setting the grip distance on a Magura HS33 brake lever

- ▶ Turn the setting screw anti-clockwise towards minus (-).
 - ⇒ The brake lever moves closer to the handlebar grip.
- ▶ Turn the setting screw clockwise towards plus (+).
 - ⇒ The brake lever moves away from the handlebar grip.

6.4.5.2 Setting the grip distance on a Magura HS22 brake lever

Only applies to bicycles with this equipment

You can adjust the brake lever position (grip distance) to your requirements.

- ✓ Use a T25 TORX® wrench to turn the setting screw (1) to adjust the grip distance.

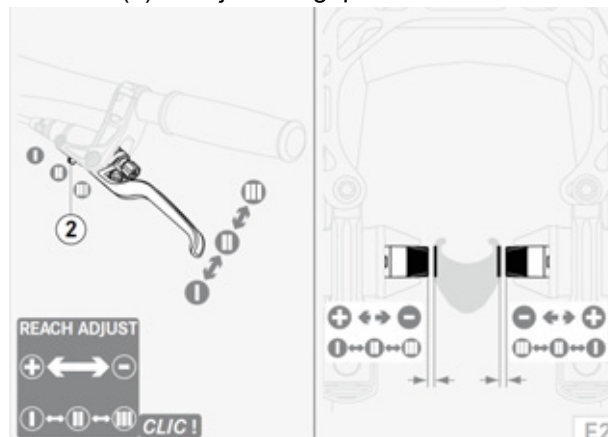

Figure 50: Setting the grip distance on a Magura HS22 brake lever

- ✓ Push the brake lever gently and hold.
 - ▶ Move the slider (2) outwards (-) to Position II or III.
 - ⇒ The brake handle moves closer to the handlebars.
 - ⇒ The brake linings move closer to the rim.
 - ⇒ The pressure point activates sooner.
 - ▶ Move the slider inwards (+) to Position II or I.
 - ⇒ The brake lever moves away from the handlebars.
 - ⇒ The brake linings move away from the rim.
 - ⇒ The pressure point activates later.

⚠ WARNING

Crash caused by incorrectly set grip distance

If brake cylinders are set or installed incorrectly, braking power may be lost completely at any time. This may cause a crash with serious injuries.

- ▶ Once the grip distance has been set, check the position of the brake cylinder. Correct if necessary.

6.4.5.3 Setting the grip distance on a Magura disc brake lever

Only applies to bicycles with this equipment

WARNING

Crash caused by incorrectly set grip distance

If brake cylinders are set incorrectly or installed wrongly, the braking power may be lost at any time. This may cause a crash with injuries.

- ▶ Ensure that the fully applied brake lever is at a minimum distance of 20 mm from the handlebars (4).

You can adjust the brake lever position (grip distance) to your requirements. Such adjustment does not affect the pressure point or the position of the brake linings.

- ✓ Use a T25 TORX® wrench to turn the setting screw (1) to adjust the grip distance.



Figure 51: Adjusting the grip distance on a Magura disc brake lever

- ▶ Turn the setting screw/twist knob (5) anti-clockwise towards minus (-).
- ⇒ The brake lever moves closer to the handlebar grip.
- ▶ Turn the setting screw clockwise towards plus (+).
- ⇒ The brake lever moves away from the handlebar grip.

6.4.5.4 Setting the pressure point on a Magura brake lever

WARNING

Brake failure due to incorrect setting

If the pressure point is set with brakes where the brake linings and brake disc have reached their wear limit, the brakes may fail and cause an accident with injury.

- ▶ Before you adjust the pressure point, ensure that the brake linings and brake disc have not reached their wear limit.

The pressure point setting is adjusted using the twist knob.

- ▶ Turn the twist knob towards the plus (+) symbol.
- ⇒ The *brake lever* moves closer to the handlebar grip. Re-adjust the grip distance as necessary.
- ⇒ The lever pressure point activates sooner.

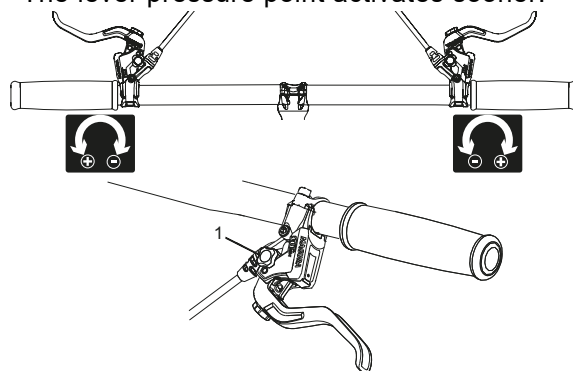

Figure 52: Using the twist knob (1) to adjust the pressure point

6.4.6 Adjusting the damping sag



Crash caused by incorrectly set suspension

If the suspension is set incorrectly, the fork may become damaged, meaning problems may occur when steering. This will cause a crash with injuries.

- ▶ Never ride the bicycle without air in the air suspension fork.
- ▶ Never use the bicycle without adjusting the suspension fork to the rider's weight.

Notice

Settings on the chassis change riding performance significantly. You need to get used to the bicycle and break it in to prevent accidents.

Sag is the percentage of total deflection that is compressed by the rider's weight, including equipment (such as a backpack), their seating position and frame geometry. Sag is not caused by riding.

SAG depends on the rider's position and weight and should be between 15% and 30% of the maximum fork deflection, depending on bicycle usage and preferences.

Greater sag (20% to 30%)

A greater sag increases sensitivity to bumps, thus producing greater suspension motion. A greater sensitivity to bumps ensures more comfortable ride performance and is used on bicycles with a longer deflection.

Decreased sag (10% to 20%)

A decreased sag reduces sensitivity to bumps, thus producing less suspension motion. A lower sensitivity to bumps ensures a firmer, more efficient ride and is generally used on bicycles with a longer deflection.

The adjustment shown here represents a basic setting. The rider should change the basic setting to suit the surface and his/her preferences.

It is advisable to make a note of the basic setting. This way, it can be used as the starting point for subsequent, optimised settings and to safeguard against unintentional changes.

6.4.6.1 Adjusting the Suntour fork steel suspension

Only applies to bicycles with this equipment

- 1 You will find the **sag setting wheel** beneath the plastic cover on the crown. Remove the plastic cover.



Figure 53: Sag setting wheel on the suspension fork crown

- ▶ Turn the **sag setting wheel** clockwise to increase the spring pre-tensioning.
 - ▶ Turn the **sag setting wheel** anti-clockwise to decrease the spring pre-tensioning.
- ⇒ You will have made the ideal setting if the shock absorber deflects 3 mm when bearing the rider's weight.
- 2 Replace the plastic cover on the crown after making the setting.

6.4.6.2 Adjusting the Suntour fork air suspension

Only applies to bicycles with this equipment

- ▶ The **air valve** is located beneath the **air valve cap** on the crown. Twist off the **air valve cap**.



Figure 54: Screw caps in different designs

- 1 Attach a high-pressure damper pump to the **air valve**.
- 2 Pump air suspension fork to the required pressure. Observe the levels in the Suntour filling pressure table. Never exceed the recommended maximum air pressure.

Rider weight	AION, NEX	XCR 32, XCR 34
< 55 kg	35 - 50 psi	40 - 55 psi
55 - 65 kg	50 - 60 psi	55 - 65 psi
65 - 75 g	60 - 70 psi	65 - 75 psi
75 - 85 kg	70 - 85 psi	75 - 85 psi
85 - 95 kg	85 - 100 psi	85 - 95 psi
< 100 kg	+ 105 psi	+ 100 psi
Maximum air pressure	150 psi	180 psi

Table 11: Suntour filling pressure table for air forks

- 3 Detach high-pressure damper pump.
 - 4 Measure the distance between the crown and the dust seal. This distance is *total deflection* of the fork.
 - 5 Push a temporarily attached cable tie downward against the dust seal.
 - 6 Put on your normal cycling clothing, including luggage.
 - 7 Sit on the bicycle in your usual riding position and support yourself against an object, such as a wall or tree.
 - 8 Get off the bicycle without allowing it to deflect.
 - 9 Measure distance between the dust seal and the cable tie.
- ⇒ This measurement is the sag. The recommended value is between 15% (hard) and 30% (soft) of the total fork deflection.
- 10 Increase or reduce air pressure until you have reached the desired sag.
 - 11 If the sag is correct, turn the **air valve cap** clockwise.
 - 12 If you are unable to achieve the required sag, an internal adjustment may be needed. Contact your specialist dealer.

6.4.6.3 Adjusting the Suntour rear frame damper

Only applies to bicycles with this equipment

Notice

If the air pressure in the rear frame damper is exceeded or undershot, the damper can be permanently damaged.

Do not exceed the maximum air pressure of 300 psi (20 bar).

- ✓ When adjusting the sag, ensure that the compression adjuster is in an open position, i.e. the **lockout lever** is in the OPEN position.
- 1 Remove the valve cap from the **air valve**. Attach a high-pressure damper pump. Adjust the rear frame damper air pressure to the rider's weight. Detach high-pressure damper pump.
 - 2 Measure the distance between the air chamber seal and the end of the rear frame damper. This distance is the *total rear frame damper deflection*.
 - 3 Put on your normal cycling clothing, including luggage. Sit on the bicycle in your usual riding position and support yourself against an object, such as a wall or tree.
 - 4 Push the O-ring downwards against the air chamber seal.
 - 5 Get off the bicycle without the suspension fork deflecting.
- ⇒ Measure the distance between the air chamber seal and the O-ring. This measurement is the sag. The recommended value is between 25% (hard) and 30% (soft) of the *total rear frame damper deflection*.
- 6 Increase or reduce the air pressure until you have reached the desired sag.
- ▶ If the sag is correct, fasten the **valve cap** onto the valve.

6.4.6.4 Adjusting the RockShox fork steel suspension

Only applies to bicycles with this equipment

The external spring preload setting compresses or decompresses the spring without changing deflection.



Figure 55: Screwing and unscrewing the pre-tension adjustment ring.

- ▶ Screw in the **Sag setting wheel** clockwise to increase pre-tensioning and reduce the sag.
- ▶ Unscrew the **Sag setting wheel** in an anti-clockwise direction to decrease pre-tensioning and increase the sag.

The spring pre-tensioning setting can be used to finely adjust the sag; however, pre-tensioning does not change spring stiffness and is not suitable to substitute the correct compression spring rate.

6.4.6.5 Adjusting the RockShox air suspension

Only applies to bicycles with this equipment

- ✓ When adjusting the sag, ensure that all dampers are in the open position, i.e. turned anti-clockwise until they stop.
- ✓ The pressure is to be measured at an ambient temperature of 21 to 24 °C.

- 1 The **air valve** is located under a cover on the head of the shock absorber. Unscrew the **air valve cap** in an anti-clockwise direction.

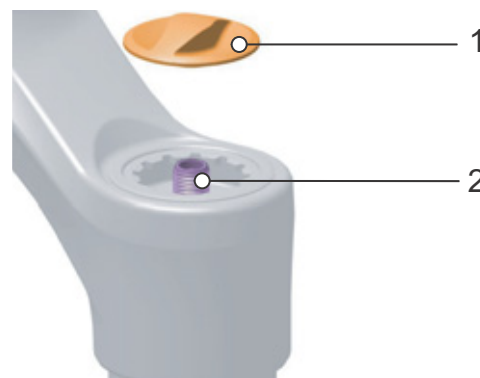

Figure 56: Removing the cover (1) from the air valve (2)

- 2 Place a high-pressure pump on the valve.
- 3 Pump the suspension fork to the required pressure. Observe the levels in the air pressure table.

Rider weight	RockShox Lyrik SELECT	
< 55 kg	< 55 psi	< 3.8 bar
55 - 63 kg	55 - 65 psi	3.8 - 4.5 bar
63 - 72 kg	65 - 75 psi	4.5 - 5.2 bar
72 - 81 kg	75 - 85 psi	5.2 - 5.9 bar
81 - 90 kg	85 - 95 psi	5.9 - 6.6 bar
90 - 99 kg	95 - 105 psi	6.6 - 6.8 bar
> 99 kg	105 + psi	6.8+ bar
Max. pressure	163 psi	11.2 bar

Table 12: Filling pressure table for RockShox LYRIK SELECT air fork

- 4 The recommendations for air pressure in the front wheel suspension are also indicated on the rear of the fork and can be found at <https://trailhead.rockshox.com/en>.
- 5 Remove the high-pressure pump.

- 6 Put on your normal cycling clothing, including luggage. Ask someone to hold the bicycle. Stand on the pedals while wearing cycling clothing. Allow the damper to deflect three times. Sit or stand on the bicycle in a normal riding position.
- 7 Ask your helper to push the **O-ring** downwards until it reaches the top of the dust wiper seal.

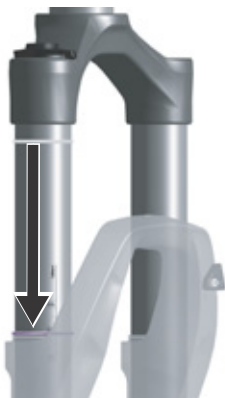

Figure 57: Moving the O-ring on the suspension fork

- 8 Get off the bicycle without allowing it to deflect. Measure or read the distance between the dust wiper and the O-ring end or cable tie. This measurement is the sag. The recommended sag is between 10% and 20% (hard) or 20% to 30% (soft).



Figure 58: Mandatory sag range (green) and forbidden sag range

- 9 Increase or reduce the air pressure until you have reached the desired sag. If the sag is correct, tighten the **air valve cap** on the valve in a clockwise direction.
- 10 If you are unable to achieve the desired sag, internal settings may need to be made. Contact your specialist dealer.

6.4.6.6 Adjusting the RockShox rear frame damper

Only applies to bicycles with this equipment

Notice

If the air pressure level in the rear frame damper is exceeded or not reached, the damper can be permanently damaged. You will find the specifications on the rear frame damper.

- ✓ When adjusting the sag, ensure that all dampers are in the open position, i.e. turned anti-clockwise until they stop.

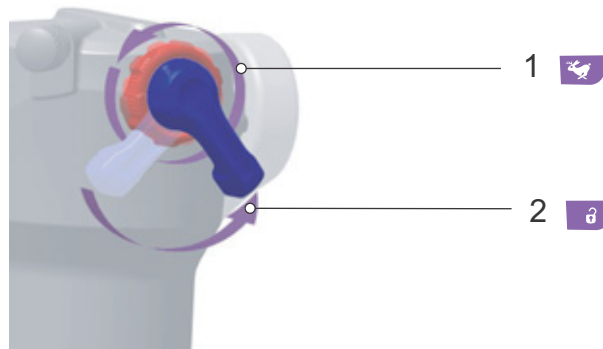

Figure 59: Opening the rebound damper (1) and compression adjuster (2)

- 1 Release air completely from the rear frame damper.
- 2 Pressurise the air spring chamber with a 100 PSI (6.9 bar) high pressure damper pump.
- 3 Detach high-pressure damper pump.
- 4 Do not deflect the suspension.
- 5 Fully deflect the rear frame damper five times to compensate the positive and negative air suspension.
- 6 Use a high pressure damper pump to fill the rear frame damper to the required pressure level for the rider's total weight, including their clothing.
Example: 160 lbs (73 kg) = 160 PSI (11 bar)
- 7 Deflect rear frame damper to compensate the air pressure.
- 8 Ask someone to hold the bicycle. Stand on the pedals while wearing cycling clothing. Deflect rear frame damper fully gently two or three times.

- 9 Ask your helper to push the O-ring against the wiper seal.



Figure 60: Moving the O-ring on the rear frame damper

- 10 Read the sag value on the scale.
The optimum sag percentage is 25%. The sag level may be adjusted by $\pm 5\%$, depending on the rider's preferences (20% to 30%).
- 11 The air pressure must be adjusted if the sag level is not reached.
- Increase the air pressure to reduce the sag.
 - Decrease the air pressure to increase the sag.

6.4.7 Adjusting the rebound damping

Rebound damping in the suspension fork and the rear frame damper determines the speed at which the rear frame damper rebounds after being subjected to load. Rebound damping controls the suspension fork extension and rebound speed, which, in turn, has an impact on traction and control.

Rebound damping can be adjusted to the rider's weight, spring stiffness, deflection, the terrain and the rider's preferences.

If the air pressure or spring stiffness increases, the extension and rebound speeds also increase. Rebound damping may need to be increased to achieve an optimal setting if the air pressure or spring stiffness are increased.

The damper rebounds at a controlled speed if the fork is optimally adjusted. The wheel stays in contact with the ground when passing over bumps (blue line).

The fork head, handlebars and rider broadly follow the terrain (green line) when riding over bumps. The suspension motion is predictable and controlled.



Figure 61: Optimum fork riding performance

The rear frame damper rebounds at a controlled speed if it is optimally adjusted. The rear wheel does not bounce off rough surfaces or the ground; it stays in contact with the ground instead (blue line).

The saddle is raised slightly if the bump is compensated and gently sinks downwards when the suspension deflects as soon as the wheel touches the ground after the bump. The rear frame damper rebounds in a controlled way, so that the rider remains sitting in a horizontal position when the next bump is absorbed. The suspension motion is predictable and controlled and the rider is not thrown upwards or forwards (green line).



Figure 62: Optimum rear frame damper riding performance

6.4.7.1 Adjusting the Suntour air suspension fork

Only applies to bicycles with this equipment

- 1 Turn the **Suntour rebound screw** in a clockwise direction to the closed position until it stops.

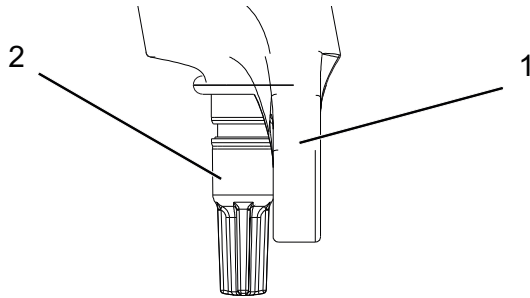

Figure 63: Suntour rebound screw (2), fork (1)

- 2 Turn the **Suntour rebound screw** slightly in an anti-clockwise direction.
- 3 Adjust the rebound in such a way that the fork rebounds quickly, but without bottoming out upward. Bottoming out refers to when the fork rebounds too quickly and stops moving abruptly once it has reached the full rebound distance. You can hear and feel a slight impact when this happens.

6.4.7.2 Adjusting the Suntour rear frame damper

Only applies to bicycles with this equipment



Figure 64: Suntour rebound adjuster wheel (1) on the rear frame damper

- ▶ Turn the rebound adjuster wheel in the – direction to increase rebounding.
- ▶ Turn the rebound adjuster wheel in the + direction to reduce compressive deflection movements.

6.4.7.3 Adjusting the RockShox suspension fork

Only applies to bicycles with this equipment

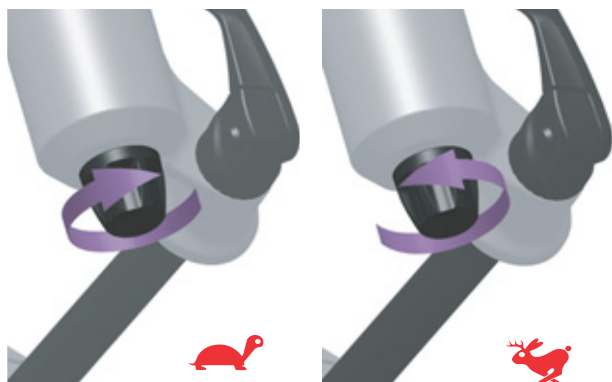

Figure 65: Adjusting RockShox rebound

- ▶ Turn the rebound adjuster clockwise towards the tortoise symbol to reduce the rebound speed (slower return).
- ▶ Turn the rebound adjuster clockwise towards the hare symbol to increase the rebound speed (faster return).

6.4.7.4 Adjusting the RockShox rear frame damper

Only applies to bicycles with this equipment

The rebound damper defines the speed at which the rear frame damper rebounds after being subjected to load or impact. The rebound adjuster setting depends on the air pressure setting. A higher sag requires lower rebound damping.

✓ The sag is set.

- 1 Turn the **Rebound damper adjuster** clockwise towards the tortoise symbol to reduce the rebound speed (slower return).



Figure 66: Reducing the rebound speed

- 2 Turn the **rebound damper adjuster** clockwise towards the hare symbol to increase the rebound speed (faster return).



Figure 67: Increasing the rebound speed

- 3 Ride the bicycle and readjust the rebound if necessary.

6.4.8 Rear frame damper compression adjuster

The compression adjuster controls the compression lifting speed or the rate at which the rear frame damper deflects in response to slow impacts. The compression adjuster influences the absorption of bumps and its efficiency when the rider's weight shifts or during transitions, cornering, uniform impacts caused by bumps and when braking.

When optimally adjusted, the rear frame damper counteracts deflection, stays higher in its deflection range and helps the rider to maintain speed when riding on hilly parts of terrain.



Figure 68: Optimum rear frame damper riding performance on hilly terrain

Compression adjuster set to hard

- Allows the rear frame damper to move higher in the deflection range. This makes it easier for the rider to improve efficiency and maintain momentum over uniformly hilly terrain, around bends and when pedalling.
- Deflection may feel somewhat harder on more rugged terrain.

Compression adjuster set to soft

- Allows the damper to deflect quickly and easily. This may make it easier for the rider to maintain speed and momentum when riding over more rugged terrain.
- Deflection may feel somewhat less hard on more rugged terrain.



Figure 69: Optimum rear frame damper riding performance over bumps

When optimally adjusted, the rear frame damper deflects quickly and unhindered when the bike hits bumps and absorbs a bump. Traction is retained (blue line).

The saddle rises slightly when absorbing a bump (green line).

6.4.8.1 Adjusting the Suntour rear frame damper

Only applies to bicycles with this equipment

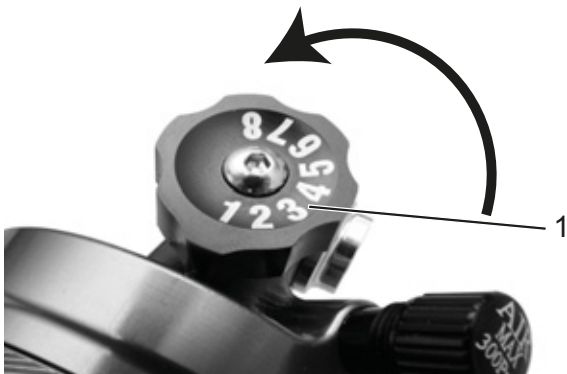

Figure 70: Suntour compression adjuster on the rear frame damper

- ▶ Turn the compression adjuster towards - to increase rebounding.
- ▶ Turn the compression adjuster towards + to reduce deflection movement.

6.4.8.2 Adjusting the RockShox compression adjuster

Only applies to bicycles with this equipment

- 1 Set the compression adjuster to the middle position.
- 2 Ride the bicycle over a small obstacle.
 - ▶ To improve efficiency on hilly and flat terrain, turn the compression adjuster clockwise to increase compression damping and hardness and reduce the deflection speed.



Figure 71: Changing compression adjuster to a harder setting

- ▶ To increase sensitivity to small bumps, turn the compression adjuster anti-clockwise to decrease damping and hardness and increase the deflection speed.



Figure 72: Changing compression adjuster to a softer setting

- 3 The ideal setting for the rebound damper has been achieved when the rebound movement of the rear wheel feels comparable to that of the front wheel.

6.5 Accessories

We recommend a parking stand into which either the front wheel or rear wheel can be inserted securely for bicycles which do not have a kickstand. The following accessories are recommended:

Description	Article number
Protective cover for electrical components	080-41000 ff
Panniers, system component*	080-40946
Rear wheel basket, system component*	051-20603
Bicycle box, system component*	080-40947
Parking stand universal stand	XX-TWO14B

Table 13: Accessories

6.5.1 Child seat

WARNING

Crash caused by incorrect child seat

The pannier rack and down tube are unsuitable for mounting child seats and may break. Such an incorrect position may cause a crash with serious injuries for the rider and the child.

- ▶ Never attach a child seat to the saddle, handlebars or down tube.

CAUTION

Crash caused by improper handling

When using child seats, the riding properties and the stability of the bicycle change considerably. This can cause a loss of control, a crash and injuries.

- ▶ You should practice how to use the child seat safely and reliably before using the bicycle in public spaces.

CAUTION

Risk of crushing due to exposed springs

The child may crush his/her fingers on exposed springs or open mechanical parts of the saddle and the seat post.

- ▶ Never install saddles with exposed springs if a child seat is being used.
- ▶ Never install seat posts with suspension with open mechanical parts and exposed springs if a child seat is being used.

Notice

- ▶ Observe the legal regulations on the use of child seats.
- ▶ Observe the operating and safety instructions for the child seat system.
- ▶ Never exceed the maximum permitted total weight.

The specialist dealer will advise on choosing a suitable child seat system for the child and the bicycle.

The specialist dealer must install the child seat the first time to ensure that it is safely fitted.

When installing a child seat, the specialist dealer makes sure that the seat and the fastening mechanism for the seat are suitable for the bicycle and that all components are installed and firmly fastened. They will also ensure that shift cables, brake cables, hydraulic lines and electrical cables are adjusted as necessary, the rider has optimum freedom of movement and the bicycle's maximum permitted total weight is complied with.

The specialist dealer will provide instruction on how to handle the bicycle and the child seat.

6.5.2 Trailer



Crash caused by brake failure

The braking distance may be longer if the trailer is carrying excessive load. The long braking distance can cause a crash or an accident and injuries.

- ▶ Never exceed the specified trailer load.

Notice

- ▶ The *operating* and safety instructions for the trailer system must be observed.
- ▶ The statutory regulations on the use of bicycle trailers must be observed.
- ▶ Only use type-approved coupling systems.

A bicycle which is approved for towing a trailer is equipped with the relevant information sign. You may only use trailers with a tongue load and weight which do not exceed the permitted values.

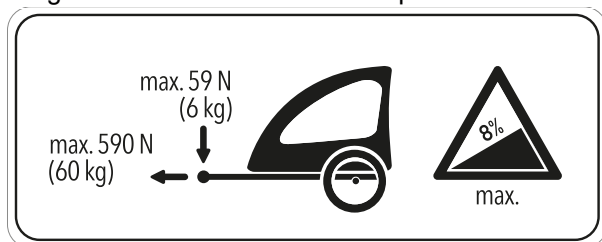

Figure 73: Trailer sign

The specialist dealer will advise on choosing a suitable trailer system for the bicycle. The specialist dealer must install the trailer the first time to ensure that it is safely fitted.

6.5.2.1 Trailer approval for ENVILOLO hub gear

Only compatible bicycle trailers are approved for ENVILOLO hub gears.

KETTLER

KETTLER QUADRIGA child trailer

Burley

Trailer	Adapter
Minnow Bee	Item no. 960038
Honey Bee	
Encore	
solo	
Cub	
D'Lite	
Normad	
Flatbed	
Tail Wagon	

Croozer

Trailer	Adapter
Croozer Kid	Item no. 122003516, XL: +10 mm Item no. 122003716 Item no. 12200715 Croozer axle nut adapter with Thule coupling
Croozer Kid Plus	
Croozer Cargo	
Croozer Dog	

Thule

Trailer	Adapter
Thule Chariot Lite	Item no. 20100798
Thule Chariot Cab	
Thule Chariot Cross	
Thule Chariot Sport	
Thule Coaster XT	

6.5.3 Pannier rack

The specialist dealer will advise on choosing a suitable pannier rack.

The specialist dealer must install the pannier rack the first time to ensure that it is safely fitted.

When installing a pannier rack, the specialist dealer makes sure that the fastening mechanism is suitable for the bicycle and that all components are installed and firmly fastened. They will also ensure that shift cables, brake cables, hydraulic lines and electrical cables are adjusted as necessary, the rider has optimum freedom of movement and the bicycle's maximum permitted total weight is not exceeded.

The specialist dealer will provide instruction on how to handle the bicycle and the pannier rack.

6.5.4 Suspension fork coil spring

If the desired suspension fork sag cannot be achieved after adjustment, the coil spring assembly must be replaced with a softer or harder spring.

A softer coil spring assembly must be installed to increase the sag.

A harder coil spring assembly must be installed to decrease the sag.

6.5.5 Tubeless and airless

Riding a bike without tyre tubes reduces the risk of tyre punctures and even avoids them completely.

The specialist dealer will advise you on choosing a suitable tyre system for the bicycle.

The conversion to tubeless or airless tyres must be carried out by a specialist dealer to ensure the safety.

6.6 Before each ride

► Check the bicycle before each ride.

⇒ Take the bicycle out of service if you spot any anomalies.

<input type="checkbox"/>	Check that the bicycle is complete.
<input type="checkbox"/>	Check that the lighting, reflector and brake, for instance, are sufficiently clean.
<input type="checkbox"/>	You must check that the mudguards, the pannier rack and the chain guard are securely installed.
<input type="checkbox"/>	Check that the front and rear wheels run true. This is particularly important if the bicycle has been transported or secured with a lock.
<input type="checkbox"/>	Check the valves and the tyre pressure. Adjust as necessary before each ride.
<input type="checkbox"/>	If the bicycle has a hydraulic rim brake, check whether the locking levers are fully closed in their final positions.
<input type="checkbox"/>	Check the front and rear wheel brakes to make sure that they are working properly. To do so, push the brake levers while stationary to check whether resistance is generated in the usual brake lever position. The brake must not lose any brake fluid.
<input type="checkbox"/>	Check that the riding light is working.
<input type="checkbox"/>	Check for unusual noises, vibrations, smells, staining, deformation, cracks, scores, abrasion and wear. This indicates material fatigue.
<input type="checkbox"/>	Inspect suspension system for cracks, dents, bumps, parts or leaking oil. Look at concealed sections on the bicycle's lower surfaces.
<input type="checkbox"/>	Use body weight to compress suspension system. Adjust to the optimum sag value if suspension is too soft.
<input type="checkbox"/>	If quick releases are used check them to make sure that they are fully closed in their end position. If quick release axle systems are used, make sure that all attachment screws are tightened to the correct torque.
<input type="checkbox"/>	Be alert to any unusual operating sensations when braking, pedalling or steering.

6.7 Raising the kickstand

- ▶ Use your foot to raise the kickstand completely before setting off.

6.8 Using the pannier rack



Crash caused by loaded pannier rack

The riding performance of the bicycle changes with a loaded *pannier rack*, in particular when steering and braking. This can lead to a loss of control. This may cause a crash with injuries.

- ▶ You should practice how to use a loaded *pannier rack* safely and reliably before using the bicycle in public spaces.

Crushing the fingers in the spring flap

The spring flap on the *pannier rack* operates with a high clamping force. There is a risk of crushing the fingers.

- ▶ Never allow the spring flap to snap shut in an uncontrolled manner.
- ▶ Be careful where you position your fingers when closing the spring flap.

Crash caused by unsecured baggage

Loose or unsecured objects on the *pannier rack*, e.g. belts, may become caught in the rear wheel. This may cause a crash with injuries.

Objects which are fastened to the pannier rack may cover the *reflectors* and the *riding light*. The bicycle may be overseen on public roads. This may cause a crash with injuries.

- ▶ Secure any objects which are attached to the *pannier rack* sufficiently.
- ▶ Objects fastened to the *pannier rack* must never cover the *reflectors*, the *headlight* or the *rear light*.

- ▶ Distribute the baggage as evenly as possible between the left- and right-hand side.
- ▶ We recommend the use of panniers and baggage baskets.

The maximum load bearing capacity is indicated on the *pannier rack*.

- ▶ Never exceed the maximum permitted *total weight* when packing the pannier.
- ▶ Never exceed the maximum load bearing capacity of the pannier rack.
- ▶ Never modify the pannier rack.

6.9 Using the saddle

- ▶ Do not wear studded jeans as these can damage the saddle covering.
- ▶ Wear dark clothes for your first few rides as new leather saddles can stain clothing.

6.10 Brake

WARNING

If the brakes are applied continuously for a long time (e.g. while riding downhill for a long time), the fluid in the brake system may heat up. This may create a vapour bubble. This will cause air bubbles or any water contained in the brake system to expand. This may suddenly make the lever travel wider. This may cause a crash with serious injuries.

- ▶ Release the brake regularly when riding downhill for a longer period of time.
- ▶ Never use the bicycle if the brakes don't work properly or you can feel no resistance when you grip the brake handle. Consult a specialist dealer.

The drive force of the motor is shut off during the ride as soon as the rider no longer pedals. The drive system does not switch off when braking.

Correct handling of the brake helps control the bicycle and prevents crashes.

- ▶ In order to achieve optimum braking results, do not pedal while braking.
- ▶ Shift your body weight backwards and down as far as possible.
- ▶ Practise braking and emergency braking before the bicycle is used in public spaces.

6.10.1 Using the brake lever

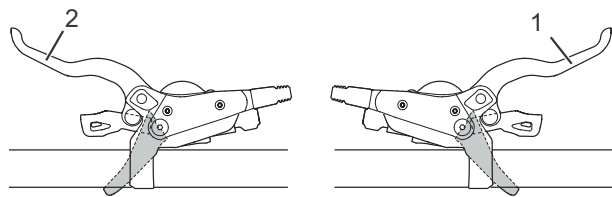

Figure 74: Front (2) and rear (1) brake lever – Shimano brake used as an example

- ▶ Push the left-hand *brake lever* to apply the *front wheel brake*.
- ▶ Push the right-hand *brake lever* to apply the *rear wheel brake*.

6.10.2 Using the back-pedal brake

Only applies to bicycles with this equipment

- 1 Move pedals a little beyond the 3 o'clock and 9 o'clock position.
- 2 Pedal in the opposite direction to the *direction of travel* until the desired speed has been reached.

6.11 Suspension and damping

6.11.1 Suspension fork compression adjuster

The compression adjuster makes it possible to make quick adjustments to the fork's suspension behaviour to adapt to changes in terrain. It is intended for adjustments made during the ride. The compression adjuster controls the compression lifting speed or the rate at which the fork deflects slow impacts. The compression adjuster influences the absorption of bumps and its efficiency when the rider's weight shifts or

during transitions, cornering, uniform impacts caused by bumps and when braking.

When optimally adjusted, the fork counteracts deflection, stays higher in its deflection range and helps the rider to maintain speed while riding on hilly parts of terrain. The fork deflects quickly and unhindered when the bike hits a bump and absorbs the bump. Traction is retained (blue line).



Figure 75: Optimum performance on hilly terrain

Compression adjuster set to hard

- Causes the suspension fork to move higher within the deflection range. This makes it easier for the rider to improve efficiency and maintain momentum over uniformly hilly terrain and around bends.
- Deflection may feel somewhat harder on more rugged terrain.

Compression adjuster set to soft

- Causes the fork to deflect quickly and easily. This may make it easier for the rider to maintain speed and momentum when riding over more rugged terrain.
- Deflection may feel somewhat less hard on more rugged terrain.



Figure 76: Optimum performance over bumps

When optimally adjusted, the fork deflects quickly and unhindered when the bike hits bumps and absorbs a bump. Traction is retained (blue line). The fork responds quickly to the bump.

The headset and handlebars rise slightly when absorbing a bump (green line).

Threshold

The damping threshold prevents deflection until a medium impact or downward force occurs. Threshold mode increases drive efficiency over level terrain.

The threshold setting can be used to improve pedalling efficiency over flat, hilly, level or slightly rugged terrain. In threshold mode, higher bicycle speeds lead to greater impact force when a bicycle hits a bump, causing the fork to deflect, and the bump is absorbed.

The fork threshold

- When the compression adjuster is in the open position (against the stop in an anti-clockwise direction), the suspension fork deflects quickly and unhindered through its entire deflection range when an impact or downward force occurs.
- When the compression adjuster is in the threshold position, the suspension fork counteracts deflection until a medium impact or downward force occurs.
- When the compression adjuster is in the blocked position (against the stop in a clockwise direction), the suspension fork counteracts deflection throughout its deflection range until a strong impact or downward force occurs.

The rear frame damper threshold

- When the compression adjuster is in the open position, the rear frame damper deflects quickly and unhindered through its entire deflection range.
- When the compression adjuster is in the threshold position, the rear frame damper counteracts deflection until a medium impact or downward force occurs.
- When the compression adjuster is in the blocked position, the rear frame damper counteracts deflection throughout its deflection range until a strong impact or downward force occurs.

6.11.1.1 Adjusting the Suntour compression adjuster

Only applies to bicycles with this equipment



Figure 77: Suntour compression adjuster in open (1) and closed (2) position

- ▶ The compression adjuster is open in the OPEN position.
- ▶ The compression adjuster is blocked in the LOCK position.
- ▶ The positions between OPEN and LOCK provide fine adjustment of compression damping. We recommend setting the compression adjuster to the OPEN position first.

6.11.1.2 Adjusting the RockShox compression adjuster

Only applies to bicycles with this equipment

- ▶ Turn the compression adjustment ring clockwise to increase damping in the compression adjuster (hard).



Figure 78: Changing compression adjuster to a harder setting

- ▶ Turn the compression adjustment ring anti-clockwise to decrease damping in the compression adjuster (soft).
- ▶ Turn the compression adjustment ring to the threshold position switch on the threshold function.



Figure 79: Changing compression adjuster to a softer setting

6.11.1.3 Adjusting the RockShox rear frame damper threshold

Only applies to bicycles with this equipment

- ▶ Turn the **threshold lever** to the threshold position (2) to switch on the threshold function.
- ▶ Place the **threshold lever** in the open position (1) to ensure that the damper deflects quickly and unhindered.

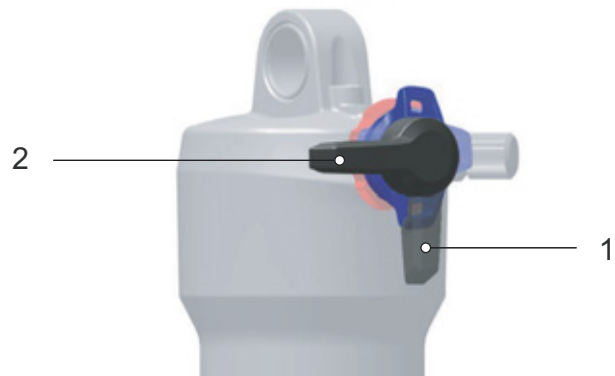

Figure 80: The lever's open position (1) and threshold position (2)

6.12 Gear shift

The selection of the appropriate gear is a prerequisite for a physically comfortable ride and making sure that the electric drive system functions properly. The ideal pedalling frequency is between 70 and 80 revolutions per minute.

- ▶ Stop pedalling briefly when changing gears. This makes it easier to switch gears and reduces wear on the drivetrain.

6.12.1 Using the derailleur gears

Only applies to bicycles with this equipment

The speed and range can be increased while applying the same force if you select the right gear. Use the derailleur gears.

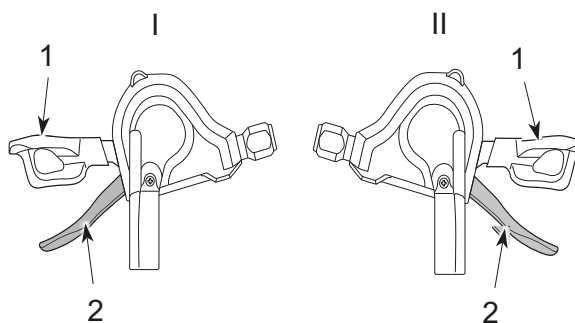

Figure 81: Down shifter (1) and up shifter (2) on the left (I) and right (II) gear shift

- ▶ Select the appropriate gear with the *shifter*.
 - ⇒ The gear shift switches the gear.
 - ⇒ The shifter returns to its original position.
- ▶ Clean and lubricate the rear derailleur if gear changes block.

6.12.2 Using a hub gear

Only applies to bicycles with this equipment



Crash caused by incorrect use

If the rider applies too much pressure on the pedals during a gear change and activates the shifter or changes several gears at a time, their feet may slip from the pedals. This may cause a crash or flip-over with injuries.

Switching down several gears to a low gear may cause the twist grip outer sleeve to suddenly come off. This will not have an adverse effect on the twist grip's correct functioning since the outer guide returns to its original position after the gear change is complete.

- ▶ Apply little pressure on the pedals while changing gears.
- ▶ Never change more than one gear at a time.

Notice

The interior hub is not completely waterproof. If water gets into the hub, it may rust and the gear switch function may no longer function as a result.

- ▶ Never use the bicycle in places where water may get into the hub.

In rare cases, noises may be heard from the rear derailleur in the hub interior after a gear change. This is normal when gears are changed.

- ▶ Never detach the hub yourself. Contact your specialist dealer.

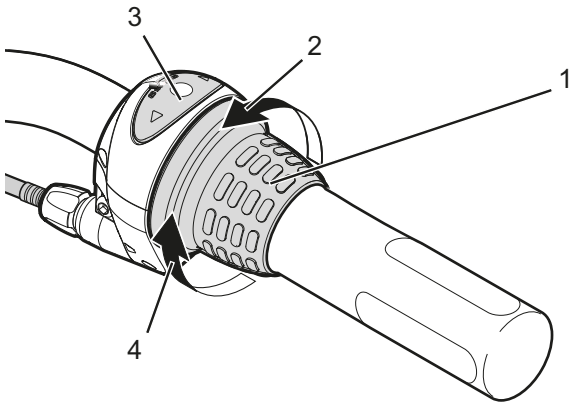

Figure 82: Example: use of Shimano Nexus gear shift

- ▶ Turn the twist grip (1) backwards to switch up a gear (4).
- ▶ Turn the twist grip (1) forwards to switch down a gear (2).
- ⇒ The gear shift switches the gear.
- ⇒ The screen display (3) shows the changed gear.

6.13 Parking the bicycle

Notice

Heat or direct sunlight can cause the *tyre pressure* to increase above the permitted maximum pressure. This can destroy the *tyres*.

- ▶ Never park the bicycle in the sun.
- ▶ On hot days, regularly check the *tyre pressure* and adjust it as necessary.

Moisture penetrating at low temperatures may impair individual functions due to the open structural design.

- ▶ Always keep the bicycle dry and free from frost.
- ▶ If the bicycle is to be used at temperatures below 3 °C, the specialist dealer must carry out an inspection and prepare it for winter use.

The bicycle's force of weight may cause the kickstand to sink into soft ground, possibly causing the bicycle to topple over as a result.

- ▶ Park the bicycle on firm, level ground only.

-
- 1 After getting off, use your foot to lower the kickstand completely before parking. Ensure that it is stable.
 - 2 Park the bicycle carefully and check that it is stable.
 - 3 Clean the suspension fork and pedals (see Section 7.1.)
 - 4 Protect the saddle with a saddle cover if you park the bicycle outside.
 - 5 Secure the bicycle with a bicycle lock.

7 Cleaning and servicing

Cleaning check list

<input type="checkbox"/>	Clean the pedals	after each ride
<input type="checkbox"/>	Clean the suspension fork and, if necessary, rear frame damper	after each ride
<input type="checkbox"/>	Chain (mainly tarmacked road)	every 250–300 km
<input type="checkbox"/>	Basic cleaning and preservation of all components	at least every six months
<input type="checkbox"/>	Clean and lubricate the height-adjustable seat post	every six months

Maintenance check list

<input type="checkbox"/>	Check for tyre wear	once a week
<input type="checkbox"/>	Check for rim wear	once a week
<input type="checkbox"/>	Check tyre pressure	once a week
<input type="checkbox"/>	Check brakes for wear	once a month
<input type="checkbox"/>	Check electrical cables and Bowden cables for damage and ensure they are fully functional	once a month
<input type="checkbox"/>	Check chain tension	once a month
<input type="checkbox"/>	Check tension of the spokes	every three months
<input type="checkbox"/>	Check the gear shift setting	every three months
<input type="checkbox"/>	Check suspension fork and, if necessary, rear frame damper for wear and ensure fully functional	every three months
<input type="checkbox"/>	Check for wear on brake discs	at least every six months

WARNING

Crash caused by brake failure

The brake system is not designed for use on a bicycle which is placed on its side or turned upside down. The brake may not function correctly as a result. This can cause a crash, which may result in injuries.

- ▶ If the bicycle is placed on its side or turned upside down, apply the brake a couple of times before setting off to ensure that it functions normally.

WARNING

Crash caused by brake failure

Oil or lubricant on the brake disc in a disc brake or on the rim of a rim brake can cause the brake to fail completely. This may cause a crash with serious injuries.

- ▶ Never allow oil or lubricant to come into contact with the brake disc or brake linings or on the rim of a rim brake.
- ▶ If the brake linings have come into contact with oil or lubricant, contact a dealer or a workshop to have the components cleaned or replaced.
- ▶ Apply the brakes a few times to test them after cleaning, servicing or repair.

Notice

Water may enter the inside of the bearings if you use a steam jet. This dilutes the lubricant inside, the friction increases and, as a result, the bearings are permanently damaged in the long term.

- ▶ Never clean the bicycle with a pressure washer.

Greased parts, such as the seat post, the handlebars or the stem, may no longer be safely and reliably clamped.

- ▶ Never apply grease or oil to clamping sections.

The brake system is not designed for use on a bicycle which is placed on its side or turned upside down. The brake may not function correctly as a result. This can cause a crash, which may result in injuries. If the bicycle is placed on its side or turned upside down, apply the brake a couple of times before setting off to ensure that it functions normally. Servicing measures must be performed regularly. Contact your specialist dealer if you are unsure.

7.1 Cleaning after each ride

Required tools and cleaning agents:

- Cloth
- Air pump
- Brush
- Water
- Dish-washing liquid
- Bucket

7.1.1 Cleaning the suspension fork

- ▶ Remove dirt and deposits from the stanchions and deflector seals with a damp cloth.
- ▶ Check the stanchions for dents, scratches, staining or leaking oil.
- ▶ Check the air pressure.
- ▶ Lubricate the dust seals and stanchions.

7.1.2 Cleaning the rear frame damper

- ▶ Remove dirt and deposits from the damper body with a damp cloth.
- ▶ Check rear frame damper for dents, scratches, staining or leaking oil.

7.1.3 Cleaning the pedals

- ▶ Clean with a brush and soapy water after riding through dirt or rain.
- ⇒ Service the pedals after cleaning.

7.2 Basic cleaning

Required tools and cleaning agents:

- Cloths
- Sponge
- Air pump
- Brush
- Toothbrush
- Paintbrush
- Watering can
- Bucket
- Water
- Dish-washing liquid
- Degreaser
- Lubricant
- Brake cleaner or spirit

7.2.1 Cleaning the frame

- 1 Soak the entire frame with dish-washing detergent if the dirt is thick and ingrained.
- 2 After leaving it to soak for a short time, remove the dirt and mud with a sponge, brush and toothbrushes.
- 3 Use a watering can or your hand to rinse the frame.
- 4 Service the frame after cleaning.

7.2.2 Cleaning the stem

- 1 Clean stem with a cloth and soapy water.
- 2 Service the stem after cleaning.

7.2.3 Cleaning the wheel



Crash caused by braking hard on rims

A rim can break and block the wheel if you brake hard. This may cause a crash with serious injuries.

Check rim *wear* on a regular basis.

- 1 Check the tyres, rims, spokes and spoke nipples for any damage while cleaning the wheel.
- 2 Use a sponge and a brush to clean the hub and spokes from the inside to the outside.
- 3 Clean the rim with a sponge.

7.2.4 Cleaning the drive elements

- 1 Spray the cassette, the chain wheels and the front derailleur with a degreasing agent.
- 2 Clean coarse dirt with a brush after soaking for a short time.
- 3 Wash down all parts with dish-washing detergent and a toothbrush.
- 4 Service the drive elements after cleaning.

7.2.5 Cleaning the rear frame damper

Only applies to bicycles with this equipment

- ▶ Clean rear frame damper with a cloth and soapy water.

7.2.6 Cleaning the chain

Notice

- ▶ Never use aggressive (acid-based) cleaners, rust removers or degreasers when cleaning the chain.
- ▶ Never use chain cleaning devices or chain cleaning baths.

- 1 Slightly dampen a brush with dish-washing liquid. Brush both sides of the chain.
- 2 Dampen a cloth with soapy water. Place the cloth on the chain.
- 3 Hold and apply slight pressure while slowly turning the rear wheel, so the chain passes through the cloth.
- 4 If the chain is still dirty afterwards, clean with lubricant.
- 5 Service the chain after cleaning.

7.2.7 Cleaning the brake

WARNING

Brake failure due to water penetration

The brake seals are unable to withstand high pressures. Damaged brakes can fail and cause an accident with injury.

- ▶ Never clean the bicycle with a pressure washer or compressed air.
- ▶ Take great care when using a hosepipe. Never point the water jet directly at the seal section.
- ▶ Clean brake and brake discs with a brush, water and dish-washing detergent.
- ▶ Clean brake discs thoroughly with brake cleaner or spirit.

7.2.8 Cleaning the saddle

Notice

- ▶ Never clean with a pressure washer.
- ▶ Never clean with solvent or chemical agents.
- ▶ Clean the saddle with lukewarm water and a cloth dampened with natural soap.

7.3 Servicing

Required tools and cleaning agents:

- Cloths
- Toothbrushes
- Dish-washing liquid
- Care oil for frames
- Silicone or Teflon oil
- Acid-free lubricating grease
- Fork oil
- Chain oil
- Degreaser
- Spray oil
- Teflon spray

7.3.1 Servicing the frame

- ▶ Dry the frame.
- ▶ Spray with care oil.
- ▶ Clean off the care oil again after a short time.

7.3.2 Servicing the stem

- ▶ Apply silicone or Teflon oil to the stem shaft tube and the quick release lever pivot point.
- ▶ If you have speedlifter Twist, also apply oil to the unlocking bolt using the groove in the speedlifter body.
- ▶ Apply a little acid-free lubricant grease between the stem quick release lever and the sliding piece to reduce the quick release lever operating force.

7.3.3 Servicing the fork

- ▶ Treat the dust seals with fork oil.

7.3.4 Servicing the drive elements

- 1 Spray the cassette, the chain wheels and the front derailleur with a degreasing agent.
- 2 Clean coarse dirt with a brush after soaking for a short time.
- 3 Wash down all parts with dish-washing detergent and a toothbrush.
- 4 Treat front and rear derailleur articulated shafts and jockey wheels with Teflon spray.

7.3.5 Servicing the pedals

- ▶ Treat pedals with spray oil.

7.3.6 Servicing the chain

- ▶ Lubricate the chain thoroughly with chain oil.

7.4 Maintenance

The following maintenance measures must be performed on a regular basis.

7.4.1 Wheel



Crash caused by braking hard on rims

A rim can break and block the wheel if you brake hard. This may cause a crash with serious injuries.

- ▶ Check rim *wear* on a regular basis.

1 Check the *tyres* for wear.

2 Check the *tyre pressure*.

3 Check the *rims* for wear.

⇒ The rims of a rim brake with invisible wear indicator are worn as soon as the wear indicator becomes visible in the area of the rim joint.

⇒ The rims with visible wear indicator are worn as soon as the black, all-round groove on the pad friction surface is no longer visible. We recommend that you also replace the *rims* with every second brake lining replacement.

4 Check the tension of the spokes.

7.4.1.1 Checking the tyres

- ▶ Check the tyre wear. The tyre is worn if the anti-puncture protection or the carcass cords are visible.

⇒ A specialist dealer will need to change the tyre if it is worn.

7.4.1.2 Checking the rims

- ▶ Check the *rims* for wear. The rims are worn as soon as the black, all-round groove on the pad friction surface becomes invisible.

⇒ Contact your specialist dealer to have the rims replaced. We recommend that you also replace the *rims* at the same time as every second brake lining replacement.

7.4.1.3 Checking and adjusting the tyre pressure

Notice

If the tyre pressure is too low in the tyre, the tyre does not achieve its load bearing capacity. The tyre is not stable and may come off the rim.

If the tyre pressure is too high, the tyre may burst.

- ▶ Check the tyre pressure as per specifications.
- ▶ *Adjust the tyre pressure as necessary.*

Dunlop valve

Only applies to bicycles with this equipment



The tyre pressure cannot be measured on the simple Dunlop valve. The tyre pressure is therefore measured in the filling hose when pumping slowly with the bicycle pump.

It is recommendable to use a bicycle pump with a pressure gauge. The operating instructions for the bicycle pump must be adhered to.

- 1 Unscrew and remove the valve cap.
- 2 Connect the bicycle pump.
- 3 Pump up the tyre slowly and pay attention to the tyre pressure in the process.
- 4 Adjust the tyre pressure according to specifications in the bicycle pass.
- 5 If the tyre pressure is too high, unfasten the union nut, let air out and re-tighten the union nut.
- 6 Remove the bicycle pump.
- 7 Screw the valve cap tight.
- 8 Screw the rim nut gently against the rim with the tips of your fingers.

Presta valve

Only applies to bicycles with this equipment



- ✓ It is recommendable to use a bicycle pump with a pressure gauge. The operating instructions for the bicycle pump must be adhered to.

- 1 Unscrew and remove the valve cap.
- 2 Open the knurled nut around four turns.
- 3 Carefully apply the bicycle pump so that the valve insert is not bent.
- 4 Pump up the tyre slowly and pay attention to the tyre pressure in the process.
- 5 Correct the tyre pressure as per the specifications on the tyre.
- 6 Remove the bicycle pump.
- 7 Tighten the knurled nut with your fingers.
- 8 Screw the valve cap tight.
- 9 Screw the rim nut gently against the rim with the tips of your fingers.

Schrader valve

Only applies to bicycles with this equipment



- ✓ It is recommendable to use a bicycle pump with a pressure gauge. The operating instructions for the bicycle pump must be adhered to.

- 1 Unscrew and remove the valve cap.
 - 2 Attach the bicycle pump.
 - 3 Pump up the tyre slowly and pay attention to the tyre pressure in the process.
- ⇒ The tyre pressure has been adjusted as per the specifications.
- 4 Remove the bicycle pump.
 - 5 Screw the valve cap tight.
 - 6 Screw the rim nut (1) gently against the rim with the tips of your fingers.

7.4.2 Brake system



Crash caused by brake failure

Worn brake discs and brake linings, as well as a lack of hydraulic fluid in the brake cable, reduce the braking power. This may cause a crash with injuries.

- ▶ Check the brake disc, brake linings and hydraulic brake system on a regular basis. Contact your specialist dealer if any of these components have become worn.

The maintenance interval for the brake depends on the weather conditions and how frequent the bicycle is used. If the bicycle is used under extreme conditions such as rain, dirt or high mileage, maintenance must be performed more frequently.

7.4.3 Checking the brake linings for wear

Check brake linings after brake has been fully applied 1,000 times.

- 1 Check that the brake linings are no less than 1.8 mm wide at any point and no less than 2.5 mm between the brake lining and supporting plate.
 - 2 Push brake lever and hold. In doing so, check the transport safety wear gauge can fit between the brake lining supporting plates.
- ⇒ The brake linings have not reached their wear limit. Contact your specialist dealer if any of these components have become worn.

7.4.4 Checking the pressure point

- ▶ Pull brake lever and hold repeatedly several times.
- ⇒ If you are unable to clearly detect the pressure point and it changes, the brake needs to be bled. Contact your specialist dealer.

7.4.5 Checking the brake discs for wear

- ▶ Check that the brake disc measures no less than 1.8 mm in depth at any point.
- ⇒ The brake discs have not reached their wear limit yet; brake discs need to be replaced if they have. Contact your specialist dealer.

7.4.6 Checking the electrical cables and brake cables

- ▶ Check all visible electrical cables and Bowden cables for damage. If the sheathing is compressed, a brake is defective or a light does not work, the bicycle must be removed from service until the lines or cables have been repaired. Contact your specialist dealer.

7.4.7 Checking the gear shift

- ▶ Check the gear shift and the *shifter* or the *gear twist grip* setting and adjust as necessary.

7.4.8 Checking the stem

- ▶ The stem and quick release system must be inspected at regular intervals. The specialist dealer should adjust them if necessary.
- ▶ If the hexagon socket head screw is also loosened, the headset backlash also needs to be adjusted. Medium-strength thread locker, such as Loctite blue, then needs to be applied to the loosened screws and the screws tightened as per specifications.
- ▶ Contact your specialist dealer if there is any wear or signs of corrosion.

7.4.9 Checking the belt and chain tension

Notice

Excessive chain tension increases wear.

If the chain tension is too low, there is a risk that the *chain* or the *drive belt* will slip off the *chain wheels*.

► Check the chain tension once a month.

- 1 Check the chain tension in three or four positions, turning the crank a full revolution.

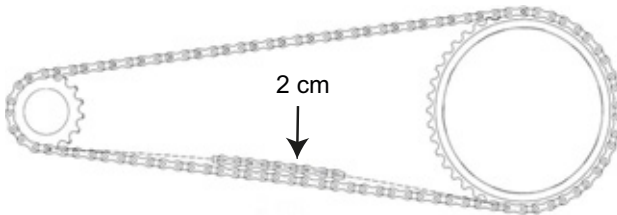

Figure 83: Checking the chain tension

- 2 If the *chain* can be pushed more than 2 cm, the *chain* or *drive belt* will need to be tensioned again by the specialist dealer.
 - 3 If the *chain* or the *drive belt* can only be pushed up and down less than 1 cm, you will need to slacken the *chain* or the *drive belt*.
- ⇒ The optimum chain tension is achieved if the *chain* or the *drive belt* can be pushed a maximum of 2 cm in the middle between the pinion and the toothed wheel. The crank must also turn without resistance.
- 4 If a hub gear is fitted, the rear wheel must be pushed backwards or forwards to tighten the chain. Contact your specialist dealer.
 - 5 Check the handlebar grip is firmly in position.



8 Maintenance

WARNING

Injury due to damaged brakes

Special tools and specialist knowledge are required to repair the brakes. Incorrect or unauthorised assembly can damage the brakes. This may lead to an accident with injuries.

- ▶ Only specialist dealers may carry out repairs on brakes.
- ▶ Only carry out work or changes, such as dismantling, sanding or painting, which are permitted and described in the brake operating instructions.

Injury to the eyes

Problems may arise if the settings are not made properly and you may sustain serious injuries as a result.

- ▶ Always wear safety glasses during maintenance work.

CAUTION

Crash caused by material fatigue

If the service life of a component has expired, the component may suddenly fail. This may cause a crash with injuries.

- ▶ Have the specialist dealer carry out six-monthly basic cleaning of the bicycle, preferably at the same time as the required servicing work.

Hazard for the environment due to toxic substances

The brake system contains toxic and environmentally harmful oils and lubricants. Such fluids will contaminate if they enter the sewers or groundwater.

- ▶ Dispose of lubricants and oils left over after repairs in an environmentally responsible way in accordance with statutory regulations.

You must have the specialist dealer perform maintenance every six months as a minimum. This is the only way to ensure that the bicycle remains safe and fully functional. No matter whether disc brakes need replacing, brakes venting or wheels changing, many maintenance tasks require technical expertise, special tools and special lubricants. The bicycle may become damaged if the stipulated maintenance intervals and procedures are not carried out. That is why only specialist dealers may carry out maintenance.

- ▶ The retailer will check the bicycle based on the maintenance table in the Section 11.3.
- ▶ The specialist dealer will inspect the bicycle for any signs of material fatigue during basic cleaning.
- ▶ The specialist dealer will dismantle and clean the entire suspension fork interior and exterior. They will clean and lubricate the dust seals and slide bushings, check the torques and adjust the fork to the rider's preferred position. They will also replace the sliding collar if the clearance is too great (more than 1mm on the fork bridge).
- ▶ The specialist dealer will fully inspect the interior and exterior of the rear frame damper, overhaul the rear frame damper, replace all air seals on air forks, overhaul the air suspension, change the oil and replace the dust wipers.
- ▶ They will pay particular attention to rim and brake wear. The spokes are re-tightened in accordance with the findings.

8.1 Suspension system

The correct execution of maintenance on the suspension system not only guarantees a long service life, but also ensures optimal performance. Each maintenance interval shows the maximum cycling hours for the corresponding type of recommended maintenance. Depending on terrain and environmental conditions, the performance can be optimised through shorter maintenance intervals.

8.1.1 Rear frame damper

Only applies to bicycles with this equipment

Maintenance intervals

RockShox rear frame damper		
<input type="checkbox"/>	Service air chamber assembly	Every 50 hours
<input type="checkbox"/>	Service damper and spring	Every 200 hours
FOX rear frame damper		
<input type="checkbox"/>	Complete maintenance (full interior and exterior inspection, damper overhaul, air spring overhaul, oil change and dust wiper replacement)	Every 125 hours or once a year
Suntour rear frame damper		
<input type="checkbox"/>	Complete shock absorber service including damper reassembly and air seal replacement	Every 100 hours

WARNING

Injury due to explosion

The air chamber is pressurised. If the air system is serviced in a rear frame damper, it can explode and cause serious injury.

- ▶ Wear safety goggles, protective gloves and safety clothing when assembling or carrying out maintenance on the bicycle.
- ▶ Release the air for the air chambers. Detach all air insert fitments.
- ▶ Never service or dismantle a rear frame damper if it has not completely rebounded.

WARNING

Intoxication from suspension oil

Suspension oil is toxic to the touch, irritates respiratory tracts and causes cancer, sterility and mutation in germ cells.

- ▶ Always wear safety goggles and nitrile gloves when working with suspension oil.
- ▶ Never perform maintenance when you are pregnant.
- ▶ Use an oil catchment tray under the section where the rear frame damper is serviced.

CAUTION

Hazard for the environment due to toxic substances

The rear frame damper contains toxic and environmentally harmful oils and lubricants. Such fluids will contaminate if they enter the sewers or groundwater.

- ▶ Dispose of lubricants and oils left over after repairs in an environmentally responsible way in accordance with statutory regulations.

Special tools, special lubricants and knowledge of suspension components are required to maintain and repair the rear frame damper.

The rear frame damper may become damaged if the procedure is not followed as described. Only specialist dealers may carry out maintenance on rear frame damper.

8.1.2 Suspension fork

Only applies to bicycles with this equipment

Maintenance intervals

Suntour suspension fork		
<input type="checkbox"/>	Maintenance 1 Functional check, fastening and wear test	Every 50 hours
<input type="checkbox"/>	Maintenance 2 Maintenance 1 + cleaning entire fork interior and exterior / cleaning and lubrication of dust seals and guides/ plastic bushings / check torques	Every 100 hours
FOX suspension fork		
<input type="checkbox"/>	Full maintenance (complete interior/ exterior inspection, damper overhaul, replacement of air seals on air forks, air suspension overhaul, oil change and dust wiper replacement).	Every 125 hours or once a year
RockShox suspension fork		
<input type="checkbox"/>	Maintenance of stanchions for: Paragon™, XC™ 28, XC 30, 30™, Judy®, Recon™, Sektor™, 35™*, Bluto™, REBA®, SID®, RS-1™, Revelation™, PIKE®, Lyrik™, Yari™, BoXXer	Every 50 hours
<input type="checkbox"/>	Maintenance of spring and damper unit for: Paragon, XC 28, XC 30,30 (2015 and earlier), Recon (2015 and earlier), Sektor (2015 and earlier), Bluto (2016 and earlier), Revelation (2017 and earlier), REBA (2016 and earlier), SID (2016 and earlier), RS-1 (2017 and earlier), BoXXer (2018 and earlier)	Every 100 hours
<input type="checkbox"/>	Maintenance of spring and damper unit for: 30 (2016+), Judy (2018+), Recon (2016+), Sektor (2016+), 35 (2020+)*, Revelation (2018+), Bluto (2017+), REBA (2017+), SID (2017+), RS-1 (2018+), PIKE (2014+), Lyrik (2016+), Yari (2016+), BoXXer (2019+)	Every 200 hours

WARNING

Injury due to explosion

The air chamber is pressurised. If the air system is serviced in a faulty suspension fork, it can explode and cause serious injury.

- ▶ Wear safety goggles, protective gloves and safety clothing when assembling or carrying out maintenance on the bicycle.
- ▶ Release the air for the air chambers. Detach all air insert fitments.
- ▶ Never service or dismantle a suspension fork if it has not completely rebounded.

CAUTION

Hazard for the environment due to toxic substances

The suspension fork contains toxic and environmentally harmful oils and lubricants. Such fluids will contaminate if they enter the sewers or groundwater.

- ▶ Dispose of lubricants and oils left over after repairs in an environmentally responsible way in accordance with statutory regulations.

Special tools, special lubricants and knowledge of suspension components are required to service and repair suspension forks.

The suspension fork may be damaged if procedures are not followed as described. Only specialist dealers may carry out maintenance on the suspension fork.

8.1.3 Suspension seat post

Only applies to bicycles with this equipment

Maintenance intervals

by.schulz seat post		
<input type="checkbox"/>	Check all screws for correct tightening torques for: G1 and G2	After 250 km and every 1,500 km
Suntour suspension seat post		
<input type="checkbox"/>	Maintenance 1	Every 100 hours
RockShox suspension seat post		
<input type="checkbox"/>	Venting of remote control lever and/or maintenance of lower seat post unit for: Reverb™ A1/A2/B1, Reverb Stealth A1/A2/B1/C1*, Reverb AXS™ A1*	Every 50 hours
<input type="checkbox"/>	Venting of remote control lever and/or maintenance of lower seat post unit for: Reverb B1, Reverb Stealth B1/C1*, Reverb AXS A1*	Every 200 hours
<input type="checkbox"/>	Complete maintenance of seat post for: Reverb A1/A2, Reverb Stealth A1/A2	Every 200 hours
<input type="checkbox"/>	Complete maintenance of seat post for: Reverb B1, Reverb Stealth B1	Every 400 hours
<input type="checkbox"/>	Complete maintenance of seat post for: Reverb AXS A1*, Reverb Stealth C1*	Every 600 hours
All other suspension seat posts		
<input type="checkbox"/>	Maintenance	Every 100 hours

Special tools, special lubricants and knowledge of suspension components are required to service and repair suspension seat posts.

The suspension seat post may be damaged if procedures are not followed as described. Only specialist dealers may carry out maintenance on the suspension seat post.

8.2 Axle with quick release



Crash caused by unfastened quick release

A faulty or incorrectly installed quick release may become caught in the brake disc and block the wheel. This will cause a crash.

- ▶ Install the front wheel quick release lever on the opposite side to the brake disc.

Crash caused by faulty or incorrectly installed quick release

The brake disc becomes very hot during operation. Parts of the quick release may become damaged as a result. The quick release comes loose. This will cause a crash with injuries.

- ▶ The front wheel quick release lever and the brake disc must be situated on opposite sides.

Crash caused by incorrectly set clamping force

Excessively high clamping force will damage the quick release and cause it to lose its function.

Insufficient clamping force will cause a detrimental transmission of force. The suspension fork or the frame may break. This will cause a crash with injuries.

- ▶ Never fasten a quick release using a tool (e.g. hammer or pliers).
- ▶ Only use the clamping lever with the specified set clamping force.

8.2.1 Checking the quick release

- ▶ Check the position and clamping force of the quick release lever. The quick release lever must be flush with the lower housing. You must be able to see a slight impression on the palm of your hand when you close the quick release lever.



Figure 84: Adjusting the quick release clamping force

- ▶ Use a 4 mm hexagon socket spanner to adjust the clamping lever clamping force if required. Check the quick release lever position and clamping force.

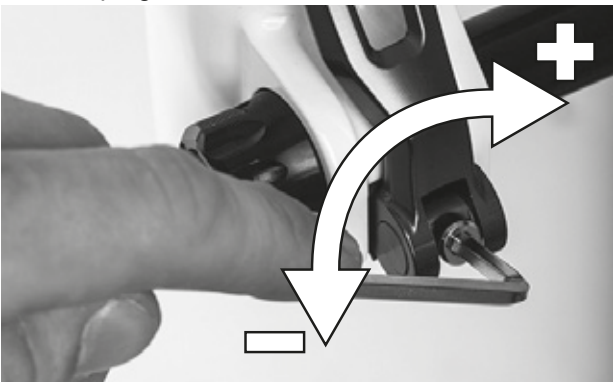

Figure 85: Adjusting the quick release clamping force

8.3 Maintaining the stem

Incorrectly fastened screws may come loose due to impact. The stem may no longer be firmly fixed in its position as a result. This will cause a crash with injuries.

- ▶ Check the handlebars and the stem's quick release system are firmly in position after the first two hours of riding.

8.4 Adjusting the gear shift

If you cannot select the gears effortlessly, you will need to adjust the setting for the shift cable tension.

- ▶ Carefully pull the *adjusting sleeve* away from the shifter housing, turning it as you do so.
- ▶ Check the gear shift function after each adjustment.

8.4.1 Cable-operated gear shift, single-cable

Only applies to bicycles with this equipment

- ▶ For a smooth gear shift, adjust the adjusting sleeves on the shifter housing.

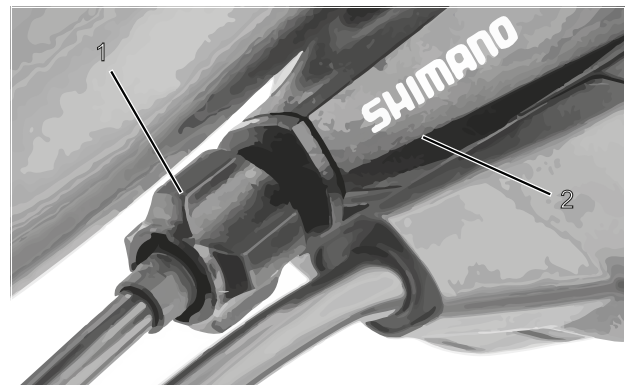

Figure 86: Adjusting sleeve (1) for the single-cable, cable-operated gear shift with shifter housing (2), example

8.4.2 Cable-operated gear shift, dual-cable

Only applies to bicycles with this equipment

- ▶ For a smooth gear shift, set the adjusting sleeves underneath the chain stay on the frame.
- ▶ The shift cable has around 1 mm play when it is pulled out gently.

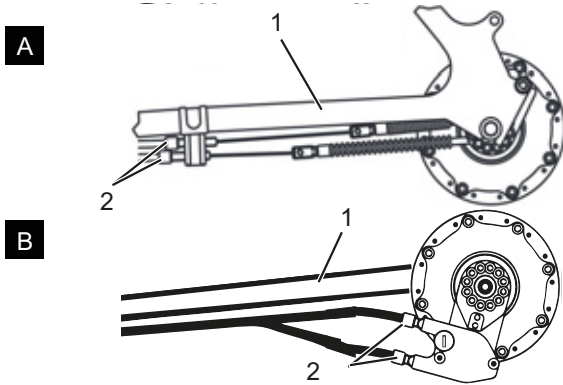

Figure 87: Adjusting sleeves (2) on two alternative versions (A and B) of a dual-cable, cable-operated gear shift on the chain stay (1)

8.4.3 Cable-operated twist grip, dual-cable

Only applies to bicycles with this equipment

- ▶ For a smooth gear shift, set the adjusting sleeves on the shifter housing.
- ⇒ There is noticeable play of around 2–5 mm (1/2 gear) when twisting the twist grip.

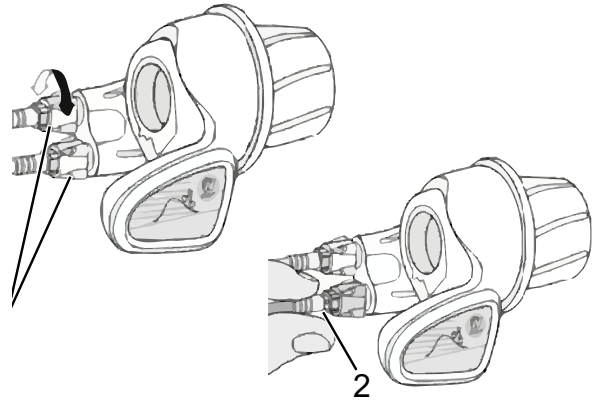

Figure 88: Twist grip with adjusting sleeves (1) and play of the gear shift (2)

9 Troubleshooting, fault clearance and repair

9.1 Lighting

Symptom	Cause	Remedy
The front light or rear light does not go on, even when the switch is pressed.	The standard setting may not have been configured correctly. The light is defective.	<ol style="list-style-type: none"> 1 Take bicycle out of service immediately. 2 Contact your specialist dealer.

Table 14: Lighting error solution

9.2 Gear shift

Symptom	Cause	Remedy
When you use an electronic gear shift, you can feel that pedal assistance becomes weaker when the gear is changed.	This is because the on-board computer sets the pedal assistance to the optimum level.	▶ This is not a malfunction.
A noise can be heard after switching.		▶ Contact your specialist dealer.
It is normal to hear a noise coming from the rear wheel when cycling as normal.	The gear shift setting may not have been made properly.	▶ Contact your specialist dealer.
If the bicycle stops, gear transmission will not switch to the position pre-configured in the functional feature.	You may have applied too much pressure on the pedals.	▶ It is easier to change gears if you press onto the pedals gently.

Table 15: Gear shift error solution

9.3 Suspension fork

9.3.1 Rebound too fast

The suspension fork rebounds too quickly, producing a “pogo stick” effect, where the wheel lifts from the ground in an uncontrolled way. This impairs traction and control (blue line).

Fork head and handlebars are deflected upwards if the wheel bounces back from the ground. The rider's weight may be shifted up and back in an uncontrolled way (green line).



Figure 89: Suspension fork rebounding too quickly

Solution

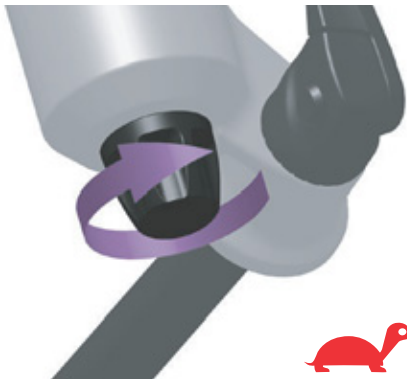

Figure 90: Turning rebound damper towards tortoise symbol

- ▶ Turn the rebound adjuster clockwise to reduce the rebound speed and increase traction and control.

9.3.2 Rebounding too slowly

The fork does not rebound quickly enough after absorbing a bump. The fork also remains deflected over subsequent bumps, which reduces deflection and increases the hardness of impacts. Available deflection, traction and control decrease (blue line).

The fork remains in a deflected state, causing the headset and handlebars to move to a lower position. The rider's weight is shifted forward after the impact (green line).



Figure 91: Suspension fork rebounding too slowly

Solution



Figure 92: Turning rebound damper towards hare symbol

- ▶ Turn the rebound adjuster anti-clockwise to increase the rebound speed and improve performance when riding over bumps.

9.3.3 Suspension too soft on inclines

The fork deflects at a low point in the terrain. The deflection is quickly used up, the rider's weight

may shift forward and the bicycle possibly lose some momentum.



Figure 93: Excessively soft suspension in the suspension fork on hilly terrain

Solution



Figure 94: Changing compression adjuster to a harder setting

- ▶ To improve efficiency on hilly and flat terrain, turn the compression adjuster clockwise to increase compression damping and hardness and reduce the deflection speed.

9.3.4 Excessively hard damping on bumps

When the bike hits a bump, the fork deflects too slowly and the wheel lifts up from the bump. Traction decreases when the wheel no longer touches the ground.

The headset and handlebars are deflected upwards significantly, which can impair control.



Figure 95: Excessively hard damping in the suspension fork on bumps

Solution



Figure 96: Changing compression adjuster to a softer setting

- ▶ To increase sensitivity to small bumps, turn the compression adjuster anti-clockwise to decrease damping and hardness and increase the deflection speed.

9.4 Rear frame damper

9.4.1 Rebound too fast

The rear frame damper rebounds too quickly, producing a “pogo stick” effect or causing the bike to bounce after the wheel hits a bump and lands on the ground again. This impairs traction and control due to the uncontrolled speed at which the damper rebounds after deflecting (blue line).

Saddle and handlebars are deflected upwards when the wheel bounces back from the ground. The rider's weight may be shifted upwards and forwards if the damper fully rebounds too quickly (green line).



Figure 97: Rear frame damper rebounding too quickly

Solution



- ▶ Turn the rebound adjuster clockwise to reduce the rebound speed and increase traction and control.

Figure 98: Turning rebound damper towards tortoise symbol

9.4.2 Rebounding too slowly

The rear frame damper does not rebound quickly enough after a bump has been compensated and is not in the required initial position when the wheel hits the next bump. The rear frame damper remains compressed during successive bumps, thus reducing deflection and ground contact and increasing hardness on the next impact. The rear wheel bounces off the second bump since the rear frame damper does not rebound quickly enough to make contact with the ground and return to the initial position again. The available deflection and traction are reduced (blue line).

The rear frame damper remains in a deflected state after contact with the first bump. When the rear wheel hits the second bump, the saddle follows the path of the rear wheel instead of remaining in a horizontal position. The available deflection and potential absorption of bumps are reduced, which causes instability and loss of control during successive bumps (green line).

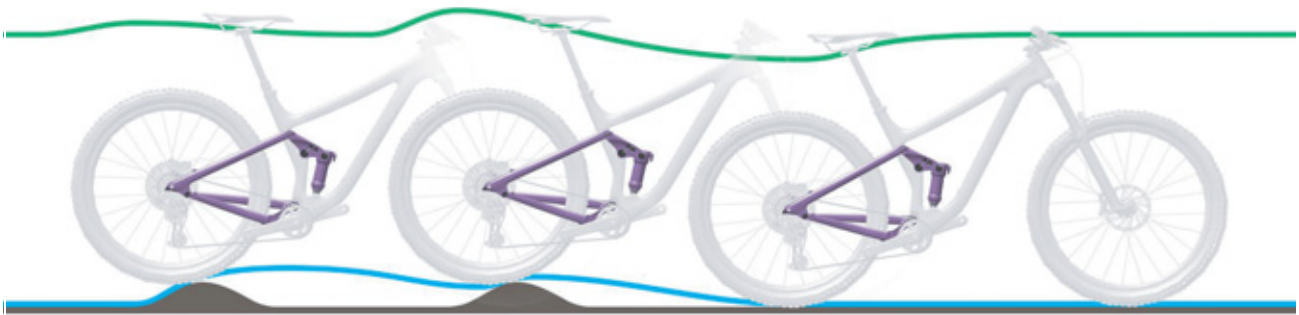

Figure 99: Rear frame damper rebounding too slowly

Solution



- ▶ Turn the rebound adjuster anti-clockwise to increase the rebound speed and improve performance when riding over bumps.

Figure 100: Turning rebound damper towards hare symbol

9.4.3 Suspension too soft on inclines

The rear frame damper deflects deeply through the deflection range. The deflection is quickly used

up, the rider's weight may shift downward and the bicycle may lose some momentum.



Figure 101: Excessively soft suspension in the rear frame damper on hilly terrain

Solution



- ▶ To improve efficiency on hilly and flat terrain, turn the compression adjuster clockwise to increase compression damping and hardness and reduce the deflection speed.

Figure 102: Changing compression adjuster to a harder setting

9.4.4 Excessively hard damping on bumps

When the bike hits a bump, the damper deflects too slowly and the rear wheel lifts up from the bump. Traction is reduced (blue line).

Saddle and rider are deflected upwards and forwards, the rear wheel loses contact with the ground and control is reduced (green line).



Figure 103: Excessively hard damping in the rear frame damper on bumps

Solution



- ▶ To increase sensitivity to small bumps, turn the compression adjuster anti-clockwise to decrease damping and hardness and increase the deflection speed.

Figure 104: Changing compression adjuster to a softer setting

9.5 Repair

Special knowledge and tools are required for many repairs. That is why only a specialist dealer may perform repairs such as:

- Replacing tyres and rims
- Replacing rims and brake linings or brake discs
- Replacing and tensioning the chain.

9.5.1 Original parts and lubricants

The individual parts of the bicycle have been selected carefully and to matched to each other.

Only original parts and lubricants must be used for maintenance and repair.

The constantly updated accessory approval and parts lists are in Section 11, Documents and Drawings.

Observe the operating instructions for the new components.

9.5.2 Replacing the lighting

- ▶ Only use components of the respective power class for replacement.

9.5.3 Adjusting the headlight

- ▶ The *headlight* must be positioned, so that its light beam meets the road 10 m in front of the bicycle.

9.5.4 Tyre clearance check

The tyre needs to be checked each time a suspension fork tyre is changed to another size.

- 1 Release pressure from the fork.
- 2 Press fork together fully.
- 3 Measure the gap between the top of the tyre and the crown's lower surface. The gap must not be less than 10 mm. If the tyre is too large, the tyre will touch the crown's lower surface if the fork is fully pressed together.
- 4 Release pressure on fork and pump it up again if it is an air suspension fork.
- 5 Take into account the fact that the gap will be smaller if there is a guard. Check again to ensure that there is sufficient clearance for the tyre.

10 Recycling and disposal

It is forbidden to dispose of batteries in domestic waste. The bicycle is made of recyclable materials, which you must dispose of and recycle separately from the domestic waste in compliance with applicable statutory regulations. Separate collection and recycling saves raw materials and ensures that all the regulations for protection of health and the environment are met when recycling the bicycle.

- ▶ Never dismantle the bicycle for disposal purposes.
- ▶ You are welcome to return the bicycle to any specialist dealer free of charge. Depending on the region, further disposal options may be available.
- ▶ Store the individual parts of the decommissioned bicycle in a dry place, free from frost, where they are protected from direct sunlight.



11 Documents

11.1 Assembly report

Date:

Frame number:

Components	Description		Criteria		Measures if rejected
	Assembly/inspection	Tests	Acceptance	Rejection	
Front wheel	Assembly		O.K.	Loose	Adjust quick release
Kickstand	Check mount fastening	Functional check	O.K.	Loose	Retighten screws
Tyres		Tyre pressure check	O.K.	Tyre pressure too low/ too high	Adjust tyre pressure
Frame	Check for damage – fracture, scratches		O.K.	Damage detected	<i>Take out of operation, new frame</i>
Handles, coverings	Check mount fastening		O.K.	Not provided	Retighten screws, new handles and coverings as specified in parts list
Handlebars, stem	Check mount fastening		O.K.	Loose	Retighten screws; new stem as specified in parts list if necessary
Steering headset	Check for damage	Functional check	O.K.	Loose	Retighten screws
Saddle	Check mount fastening		O.K.	Loose	Retighten screws
Seat post	Check mount fastening		O.K.	Loose	Retighten screws
Protective plate	Check mount fastening		O.K.	Loose	Retighten screws
Pannier rack	Check mount fastening		O.K.	Loose	Retighten screws
Attachments	Check mount fastening		O.K.	Loose	Retighten screws
Bell		Functional check	O.K.	No ring, too quiet, missing	New bell as specified in the parts list
Suspension elements					
Fork, suspension fork	Check for damage		O.K.	Damage detected	New fork as specified in the parts list
Rear frame damper	Check for damage		O.K.	Damage detected	New fork as specified in the parts list
Suspension seat post	Check for damage		O.K.	Damage detected	New fork as specified in the parts list
Brake system					
Brake lever	Check mount fastening		O.K.	Loose	Retighten screws
Brake fluid	Check fluid level		O.K.	Too little	Refill with brake fluid; new brake hoses if damaged
Brake linings	Check brake linings, brake discs and rims for damage		O.K.	Damage detected	New brake linings, brake discs and rims
Back-pedal brake braking armature	Check mount fastening		O.K.	Loose	Retighten screws
Light system					
Light cabling	Connections, correct wiring		O.K.	Cable defective, no light	New cabling
Rear light	Side light	Functional check	O.K.	No constant light	<i>Take out of service</i> ; new rear light as specified in parts list; replace if necessary
Front light	Side light, daytime riding light	Functional check	O.K.	No constant light	<i>Take out of service</i> ; new front light as specified in parts list; replace if necessary
Reflectors	All complete, state, fastening		O.K.	Damaged or not all complete	New reflectors

Components	Description		Criteria	Measures if rejected	
Drive/gear shift					
Chain/cassette/pinion/chainring	Check for damage		O.K.	Damage	Refasten if necessary or replace as specified in parts list
Chain guard/spoke guard	Check for damage		O.K.	Damage	Replace as specified in parts list
Bottom bracket axle/crank	Check mount fastening		O.K.	Loose	Retighten screws
Pedals	Check mount fastening		O.K.	Loose	Retighten screws
Shifter	Check mount fastening	Functional check	O.K.	Loose	Retighten screws
Shift cables	Check for damage	Functional check	O.K.	Loose and defective	Adjust shift cables; new shift cables if necessary
Front derailleur	Check for damage	Functional check	O.K.	Gear shift difficult or not possible	Adjust
Rear derailleur	Check for damage	Functional check	O.K.	Gear shift difficult or not possible	Adjust

Technical inspection, checking safety, test ride

Components	Description		Criteria	Measures if rejected	
	Assembly/inspection	Tests	Acceptance	Rejection	
Brake system		Functional check	O.K.	No full braking; braking distance too long	Locate defective part in brake system and correct
Gear shift under operating load		Functional check	O.K.	Problems when shifting gear	Readjust gear shift
Suspension components (fork, shock absorber, seat post)		Functional check	O.K.	Suspension too deep or no longer exists	Locate defective component and correct
Electric drive		Functional check	O.K.	Loose connection, problems when riding, accelerate	Locate defective part in electric drive and correct
Light system		Functional check	O.K.	No continuous light, too bright	Locate defective part in light system and correct
Test ride			No strange noises	Strange noises	Locate source of noise and correct

Date:	
Fitter's name:	
Final inspection by workshop manager	



11.2 Maintenance instructions

Diagnosis and documentation of current status

Date:

Frame number:

Components	Frequency	Description			Criteria		Measures if rejected
		Inspection	Tests	Maintenance	Acceptance	Rejection	
Front wheel	6 months	Assembly			O.K.	Loose	Adjust quick release
Kickstand	6 months	Check mount fastening	Functional check		O.K.	Loose	Retighten screws
Tyres	6 months		Tyre pressure check		O.K.	Tyre pressure too low/ too high	Adjust tyre pressure
Frame	6 months	Check for damage – fracture, scratches			O.K.	Damage detected	Take bicycle out of service, new frame
Handles, coverings	6 months	Wear; check if fastened securely			O.K.	Not provided	Retighten screws, new handles and coverings as specified in parts list
Handlebars, stem	6 months	Check mount fastening			O.K.	Loose	Retighten screws; new stem as specified in parts list if necessary
Steering headset	6 months	Check for damage	Functional check	Lubricating and adjustment	O.K.	Loose	Retighten screws
Saddle	6 months	Check mount fastening			O.K.	Loose	Retighten screws
Seat post	6 months	Check mount fastening			O.K.	Loose	Retighten screws
Protective plate	6 months	Check mount fastening			O.K.	Loose	Retighten screws
Pannier rack	6 months	Check mount fastening			O.K.	Loose	Retighten screws
Attachments	6 months	Check mount fastening			O.K.	Loose	Retighten screws
Bell	6 months		Functional check		O.K.	No ring, too quiet, missing	New bell as specified in the parts list
Suspension elements							
Fork, suspension fork	To manufacturer's specifications*	Check for damage – corrosion, fracture		Maintenance as specified by manufacturer Lubrication, oil change as specified by manufacturer	O.K.	Damage detected	New fork as specified in the parts list
Rear frame damper	To manufacturer's specifications*	Check for damage – corrosion, fracture		Maintenance as specified by manufacturer Lubrication, oil change as specified by manufacturer	O.K.	Damage detected	New fork as specified in the parts list
Suspension seat post	To manufacturer's specifications*	Check for damage		Maintenance as specified by manufacturer	O.K.	Damage detected	New fork as specified in the parts list
Brake system							
Brake lever	6 months	Check mount fastening			O.K.	Loose	Retighten screws
Brake fluid	6 months	Check fluid level		Depending on time of year	O.K.	Too little	Top up brake fluid; <i>take bicycle out of service</i> if damaged; new brake hoses
Brake linings	6 months	Check brake linings, brake discs and rims for damage			O.K.	Damage detected	New brake linings, brake discs and rims
Back-pedal brake braking armature	6 months	Check mount fastening			O.K.	Loose	Retighten screws
Brake system	6 months	Check mount fastening		Functional check	O.K.	Loose	Retighten screws

* see Section 8.1

Components	Frequency	Description			Criteria		Measures if rejected
		Inspection	Tests	Maintenance	Acceptance	Rejection	
Light system							
Light cabling	6 months	Connections, correct wiring			O.K.	Cable defective, no light	New cabling
Rear light	6 months	Side light	Functional check		O.K.	No constant light	New rear light as specified in parts list; replace if necessary
Front light	6 months	Side light, daytime riding light	Functional check		O.K.	No constant light	New front light as specified in parts list; replace if necessary
Reflectors	6 months	All complete, state, fastening			O.K.	Damaged or not all complete	New reflectors
Drive/gear shift							
Chain/cassette/pinion/chainring	6 months	Check for damage			O.K.	Damage	Refasten if necessary or replace as specified in parts list
Chain guard/spoke guard	6 months	Check for damage			O.K.	Damage	Replace as specified in parts list
Bottom bracket axle/crank	6 months	Check mount fastening			O.K.	Loose	Retighten screws
Pedals	6 months	Check mount fastening			O.K.	Loose	Retighten screws
Shifter	6 months	Check mount fastening	Functional check		O.K.	Loose	Retighten screws
Shift cables	6 months	Check for damage	Functional check		O.K.	Loose and defective	Adjust shift cables; new shift cables if necessary
Front derailleur	6 months	Check for damage	Functional check		O.K.	Gear shift difficult or not possible	Adjust
Rear derailleur	6 months	Check for damage	Functional check		O.K.	Gear shift difficult or not possible	Adjust

Technical inspection, checking safety, test ride

Components	Description		Criteria		Measures if rejected
	Assembly/inspection	Tests	Acceptance	Rejection	
Brake system	6 months	Functional check	O.K.	No full braking; braking distance too long	Locate defective part in brake system and correct
Gear shift under operating load	6 months	Functional check	O.K.	Problems when shifting gear	Readjust gear shift
Suspension components (fork, shock absorber, seat post)	6 months	Functional check	O.K.	Suspension too deep or no longer exists	Locate defective component and correct
Electric drive	6 months	Functional check	O.K.	Loose connection, problems when riding, accelerate	Locate defective part in electric drive and correct
Light system	6 months	Functional check	O.K.	No continuous light, too bright	Locate defective part in light system and correct
Test ride	6 months	Functional check	No strange noises	Strange noises	Locate source of noise and correct

Date:	
Fitter's name:	
Final inspection by workshop manager	

12 Glossary

Bicycle for young adults

Source: ISO 4210-2: bicycle designed for use on public roads by a young adult whose weight is less than 40 kg, with maximum saddle height of 635 mm or more and less than 750 mm. (see ISO 4210).

Brake lever

Source: EN 15194:2017: lever used to apply the brake.

Braking distance

Source: EN 15194:2017: distance that a bicycle travels from when braking commences until the bicycle reaches the point where it comes to rest.

Cargo bike

Source: DIN 79010: bicycle mainly designed to carry goods.

City and trekking bicycles

Source: ISO 4210-2: bicycle designed for use on public roads primarily for means of transportation or leisure.

Consumables

Source: EN 82079-1: any part or material that is necessary for continued use or maintenance of the product.

Decommissioning

Source: DIN 31051: intentional, unlimited interruption in an object's functional capability.

Disc brake

Source: EN 15194:2017: brake in which brake pads are used to grip the lateral faces of a thin disc attached to or incorporated in the wheel hub.

Drive belt

Source: EN 15194:2017: seamless ring belt which is used as a means of transmitting drive force.

Fault

Source: EN 13306:2018-02, 6.1: state of an item (4.2.1) characterized by inability to perform a required function (4.5.1), excluding the inability during preventive maintenance or other planned actions, or due to lack of external resources.

Folding bicycle

Source: EN-ISO 4210-2: bicycle designed to fold into a compact form, facilitating transport and storage.

Fork steerer

Source: EN 15194:2017: part of a fork that rotates about the steering axis of a bicycle frame head tube. It is normally connected to the fork crown or directly to the fork legs, and is normally the point of connection between the fork and the handlebar stem.

Fracture

Source: EN 15194:2017: unintentional separation into two or more parts.

Instructions

Source: ISO/DIS 20607:2018: part of the user information that machine manufacturers provide to machine operators; it contains guidance, instructions and tips related to the use of the machine in all its life cycle phases.

Maintenance

Source: DIN 31051: maintenance is generally performed at regular intervals and often carried out by trained technical staff. This ensures a maximum service life and low wear and tear for the maintained items. Proper maintenance is often also a pre-requisite for providing a warranty.

Maximum continuous power

Source: ZEG: the maximum continuous power is the maximum power for the electric motor output shaft during 30 minutes.

Maximum permitted total weight

Source: EN 15194:2017: weight of the fully assembled bicycle plus the rider and baggage, as specified by the manufacturer.

Maximum saddle height

Source: EN 15194:2017: vertical distance from the ground to the point where the top of the seat surface is intersected by the seat-post axis, measured with the saddle in a horizontal position and with the seat-post set to the minimum insertion depth mark.

Maximum tyre pressure

Source: EN 15194:2017: maximum tyre pressure recommended by the tyre or rim manufacturer for a safe and efficient performance. If the rim and tyre both indicate a maximum tyre pressure, the maximum inflation pressure is the lower of the two pressures indicated.

Minimum insertion depth

Source: EN 15194:2017: mark indicating the minimum insertion depth of handlebar stem into fork steerer or seat post into frame.

Model year

Source: ZEG: the model year refers to the first production year that the series-manufactured bicycle was manufactured in the version in question and is not always identical to the year of manufacture. The year of manufacture may be before the model year in some cases. If no technical modifications are made to the series, bicycles from a previous model year may also be produced after the model year in question.

Mountain bike

Source: ISO 4210-2: bicycle designed for use off-road on rough terrain, on public roads, and on public pathways, equipped with a suitably strengthened frame and other components, and, typically, with wide-section tyres with coarse tread patterns and a wide range of transmission gears.

Negative deflection

Negative deflection or sag is fork compression caused by the weight of the rider and their gear (e.g. a backpack), their sitting position and the frame geometry.

Off-road rough terrain

Source: EN 15194:2017: coarse pebble tracks, forest trails, and other general off-road tracks where tree roots and rocks are likely to be encountered.

Pressure point

Source: ZEG: the pressure point on a brake is the point on the brake lever where the brake disc and brake pads respond and the braking process is initiated.

Quick-release device, quick release

Source: EN 15194:2017: lever actuated mechanism that connects, retains or secures a wheel or any other component.

Racing bicycle

Source: ISO 4210-2: bicycle designed for amateur rides at high speed and for use on public roads having a control and steering assembly with multiple grip positions to provide an aerodynamic posture, a multi-speed transmission system and a tyre width not greater than 28 mm with the fully assembled bicycle having a maximum mass of 12 kg.

Rebound

The rebound defines the speed at which the fork rebounds after being loaded.

Seat post

Source: EN 15194:2017: component that clamps the saddle (with a bolt or assembly) and connects it to the frame.

Serial number

Source: ZEG: each bicycle has an eight-digit type number which is used to specify the design model year, the type and the version.

Slippage

Source: DIN 75204-1:1992-05: the difference in relation to vehicle speed between the vehicle speed and the speed of its wheels at their circumference.

Spare part

Source: EN 13306:2018-02, 3.5: item intended to replace a equivalent item to retain or maintain the original required function of the item.

Suspension fork

Source: EN 15194:2017: front fork incorporating controlled, axial flexibility to reduce the transmission of road-shocks to the rider.

Suspension frame

Source: EN 15194:2017: frame incorporating controlled, vertical flexibility to reduce the transmission of road-shocks to the rider.

Total deflection

Source: Benny Wilbers, Werner Koch: Neue Fahrwerkstechnik im Detail (New chassis technology in detail): The distance that the wheel travels between an unloaded and a loaded position is called total deflection. When at rest, the vehicle's mass is applied to the springs and reduces the total deflection by the *negative deflection* to the positive deflection.

Wear

Source: DIN 31051: reduction in useful life (4.3.4), caused by chemical and/or physical processes.

Weight of ready-to-ride bicycle

Source: ZEG: the indicated weight for a ready-to-ride bicycle refers to the weight of a bicycle at the time of sale. The weight of each additional accessory must be added to this weight.

Wheel

Source: ISO 4210 - 2: unit or combination of hub, rim and spokes or disc, but excluding tyre assembly.

Work environment

Source: ISO 9000:2015: set of conditions under which work is performed.

Year of manufacture

Source: ZEG: the year of manufacture is the year when the bicycle was manufactured. The production period is always from August to July of the following year.

13

Keyword index

A

- Air chamber, 15
- Articulated shaft,
 - care 64

B

- Back-pedal brake,
 - braking, 54
- Basic cleaning 62
- Battery,
 - disposing of, 84
- Belt tension, 67
- Brake arm, 16
- Brake calliper, 16
- Brake disc, 16
 - check 66
- Brake lever, 20
 - adjusting the pressure point, 37
- Brake lining, 16
 - check 66
 - maintaining, 66
- Brake,
 - check brake cables 66
 - check brake disc 66
 - check brake linings 66
 - check pressure point 66
 - securing during transport 23

C

- Cassette,
 - care 64
- Chain drive, 17
- Chain guard,
 - checking, 52
- Chain tension, 67
- Chain wheel, 17
- Chain wheels,
 - care 64
- Chain, 10, 17
 - care, 64
 - maintaining, 67

Charger,

- disposing of, 84

Child seat, 49**Clamping force,**

- Adjusting the quick releases, 26
- Checking the quick releases, 26

Control panel 20**D**

- Direction of travel, 17
- Display 20

E

- Electrical cable,
 - check 66

F

- Fork,
 - care, 64
- Frame, 10
 - care, 64
 - cleaning, 62
- Front derailleur,
 - care, 64
- Front wheel brake, 16, 17
 - braking, 54
- Front wheel, see Wheel

G

- Gear shift twist grip, 20
 - checking, 66
- Gear shift,
 - check 66
 - maintaining, 66
 - switching, 58, 60

H

- Handlebars, 10, 20
 - check 29
- Headlight, 20
- Hub, 11

I

- Initial commissioning, 24

J

- Jockey wheel,
 - care 64

M

- Minimum insertion depth marking, 34
- Motor,
 - Technical data 20
- Mudguards,
 - checking, 52

O

- On-screen indicator, 50

P

- Pannier rack, 10
 - changing, 53
 - checking, 52
 - using, 53

Pedal, 17

- care, 64
- cleaning, 62

Position, 20**R**

- Rear frame damper,
 - cleaning, 62, 63
 - structure, 14, 15, 44
- Rear wheel brake, 16, 17
- Riding light,
 - checking function, 52
- Rim brake locking lever 16
- Rim, 11
 - checking, 64
- Rim, tyres,
 - check 64
- Roller brake,
 - braking, 54

S

- Saddle, 10, 53
 - changing the saddle tilt, 33
 - changing the seat length, 34
 - cleaning, 63
 - determining the saddle height, 33, 34
 - using, 53
- Seat post, 10
- Shifter,
 - adjusting, 72
 - checking, 66
- Spoke, 11

Stem,

- care, 64
- check 29, 66
- cleaning, 62

- Suspension fork,
 - cleaning, 62

T

- Trailer, 50
- Transporting, 23
- Transporting, see Transportation
- Type number, 7
- Tyres, 11
 - check 64
 - check tyre pressure 65
 - checking, 64
 - converting 51
 - Airless 51
 - Tubeless 51

V

- Valve, 11
 - Dunlop valve, 11
 - Presta valve, 11
 - Schrader valve, 11

W

- Wheel,
 - cleaning, 62
 - installing 25, 26, 27, 28, 29
 - maintaining, 64